



HM-2-SSI PROFIBUS DP

STRAIN GAGE INPUT MODULE



INSTRUCTION MANUAL



HELM INSTRUMENT COMPANY, INC.
361 WEST DUSSEL DRIVE
MAUMEE, OHIO 43537
419-893-4356
419-893-1371 (FAX)

*Manual Rev. 1.03
1/3/2007*

Important User Information

Solid state equipment has operational characteristics differing from those of electromechanical equipment. "Safety Guidelines for the Application, Installation and Maintenance of Solid State Controls" describes some important differences between solid state equipment and hard-wired electromechanical devices. Because of this difference, and also because of the wide variety of uses for solid state equipment, all persons responsible for applying this equipment must satisfy themselves that each intended application of this equipment is acceptable.

In no event will the Helm Instrument Company be responsible or liable for indirect or consequential damages resulting from the use or application of this equipment.

The examples and diagrams in this manual are included solely for illustrative purposes. Because of the many variables and requirements associated with any particular installation, the Helm Instrument Company cannot assume responsibility or liability for actual use based on the examples and diagrams.

No patent liability is assumed by Helm Instrument Company with respect to use of information, circuits, equipment, or software described in this manual.

Reproduction of the contents of this manual, in whole or in part, without written permission of the Helm Instrument Company is prohibited.

Throughout this manual we use note to make you aware of safety considerations.



ATTENTION: Identifies information about practices or circumstances that can lead to property damage. Identifies information that is especially important for successful application and understanding of the product.

Attentions help you:

- identify a hazard
- avoid the hazard
- recognize the consequences



ATTENTION: Please check power supply ratings before proceeding! Each tonnage module consumes (+24, 173 mA +5, 220mA). Be sure to not overload the power supply.

TABLE OF CONTENTS

Preface	1
Who Should Use this Manual	1
Purpose of This Manual	1
Contents of this Manual	2
Terms and Abbreviations	3
Common Techniques Used in this Manual	5
Product Support	5
Your Questions or Comments on this Manual	5
Chapter 1	6
Overview	6
Strain Gain Transducer Operation	6
HM-2-SSI Features	7
Hardware Overview	8
Hardware Features	9
<i>Meter/Message Display:</i>	9
<i>Balance Adj. (CH. 1):</i>	9
<i>Gain Adj. (CH. 1):</i>	9
<i>Recorder Output Jack:</i>	10
<i>Gain Adj. (CH. 2):</i>	10
<i>Profibus Cable Connection:</i>	10
<i>Mode Status Led's:</i>	10
<i>Up/Down Buttons:</i>	11

<i>Select/Enter Button:</i>	11
<i>Mode/Store Button:</i>	11
Chapter 2	12
Getting Started	12
Required Tools and Equipment	12
System Operation.....	13
Sensor Wiring	13
Chapter 3	14
Channel Configuration Data and Status.....	14
Output Image Block.....	14
<i>SSI-2 PLM Output Block (DB2)</i>	14
Input Image Block.....	16
<i>SSI-2 PLM Input Block (DB1)</i>	16
Chapter 4	19
Initial Hardware Setup Procedures	19
<i>Menu Sequence:</i>	19
<i>Step 1. Set the Station Number</i>	19
<i>Step 2. Set the Hi/Low Gain Range</i>	20
<i>Step 3. Set the Scale Value</i>	20
<i>Step 4. Auto-Zero (AZ) Control</i>	20
<i>Step 5. Click on Calibration Mode</i>	20
<i>Step 6. Confirm that Profibus Communications are Online (Solid Green Status LED)</i>	20

<i>Step 7. Calibrate Channel 1</i>	20
<i>Step 8. Calibrate Channel 2</i>	20
Install GSD File Procedures.....	21
Install Siemen’s Ladder Logic Procedures	21
Chapter 5	22
System Troubleshooting Guide.....	22
Appendix A: Specifications:	28
<i>Electrical Specifications:</i>	28
<i>Physical Specifications:</i>	28
<i>Environmental Specifications:</i>	28
<i>Input Specifications:</i>	28
Appendix B: Module Diagrams:.....	29
<i>HM2-SSI Load Module</i>	29
<i>Profibus Field Wiring Diagram.....</i>	30
<i>Strain Gage & I/O Connector Wiring.....</i>	31
<i>I/O Wiring Connection.....</i>	32
Appendix C: GSD File:	33
Appendix D: Address Values:	35
Input Image:	35
Output Image:	36
Appendix E: Siemen’s Ladder Logic:	37

Preface

Read this preface to familiarize yourself with the rest of this manual. This preface covers the following topics:

- who should use this manual
- the purpose of this manual
- terms and abbreviations
- conventions used in this manual

Who Should Use this Manual

Use this manual if you are responsible for the design, installation, programming, or maintenance of an automation control system.

You should have a basic understanding of a Profibus DP network. You should understand electronic process control and be able to interpret the ladder logic instructions required to generate the electronic signals that control your application.

Purpose of This Manual

This manual is a learning and reference guide for the Helm HM-2-SSI Module. It contains the information you need to install, wire, and use the module.

Contents of this Manual

Chapter	Title	Content
	Preface	Describes the purpose, background, and scope of this manual. Also specifies the audience for whom this manual is intended and defines key terms and abbreviations used throughout this book.
1	Overview	Provides a hardware and system overview. Explains and illustrates the components of the system.
2	Installation and Wiring	Provides installation information and wiring guidelines.
3	Channel Configuration, Data and Status	Examines the channel configuration and the channel status word, and explains how the module uses configuration data and generates status during operation.
4	Initial Setup Procedures	Gives setup instructions for initial setup. This includes the hardware setup, as well as installing the GSD file, and Siemen's ladder logic.
5	Troubleshooting	Explains how to interpret and correct problems that occur while using the load module.
A	Specifications	Provides physical, electrical, Environmental, and functional Specifications for the module.
B	Module Diagrams	Included diagrams are the load module layout, Profibus wiring, strain gage wiring module I/O wiring, master/slave config. Wiring, and encoder wiring.
C	GSD File	GSD files are used by Profibus configuration tools to enable a master Profibus scanner module - either in a PLC or PC - to know what slave devices are to be communicated to, their node address, what parameters can be read and written to and more.
D	Address Values	Provides Image Blocks
E	Siemen's Ladder Logic	Provides Siemen's Ladder Logic program

Terms and Abbreviations

The following terms and abbreviations are used throughout this manual.

Calibration - Procedure, performed by trained personnel, where machine or press is dynamically loaded to impact on load cells. This is the process of linearity measuring to determine the loading capacity of the machine.

Calibration Number - An amplification values established during machine calibration or pre-assigned on force load cells.

Channel - Refers to one of two, strain gage inputs available on the modules terminal block.

Configuration Word - Contains the channel configuration information needed by the module to configure and operate each channel. Information is written to the configuration word through the logic supplied in your ladder program.

HM-2-SSI - Helm monitoring module; provides processor input from up to two sensors.

Gain - Amplification of an input signal.

Load/Force - Measurement of impact during a machine cycle. Sensors provide the input for this measurement.

Look Window - Resolver or cam activated window which allows specific degrees in a machine cycle to be processed.

Low Alarm Inhibit - Number of consecutive machine cycles where low alarm is inhibited. Used in a process where machine cycles several times before running speed is established.

LSB - (Least Significant Bit) Refers to a data increment defined as the full scale range divided by the resolution. The LSB represents the smallest value within a string of bits.

Monitor Parts Mode - Status condition used during production run. Sample and compare logic is enabled. On resolver based systems, tracking alarm limits can be enabled.

Press Curve - Machine manufacturers provide this data table which defines limits on maximum load that should be exerted at a given degree of press stroke. This data is stored in EEPROM memory in the Helm processing unit.

Press Curve Alarm - Indication of resolver position and load when load at a given degree meets or exceeds press curve profile.

Resolution - The smallest detectable change in a measurement, typically expressed in engineering units (e.g. 0.15C) or as a number of bits. For example a 12-bit system has 4,096 possible output states. It can therefore measure 1 part in 4096.

Resolver - Sometimes called encoder. Device attached on a machine to determine stroke position. Sine/cosine based resolver required for Helm systems.

Reverse Load - Measurement of negative load/force being exerted on machine following the break-through of material, also referred to as snap through.

Sample - Load/force values established from a series of machine cycles, also defined as benchmark.

Sample Count - User input value used to specify how many machine cycles to base the sample on.

Sampling time - The time required by the A/D converter to sample an input channel.

Scale - Value used to describe the press/machine overall tonnage. Set for maximum value of one channel. For example, settings for a 150 ton press = 75.

Setup Mode - Status condition of monitor typically enables during die setup. Machine capacity alarms are enabled. On resolver based systems, press curve alarm can be enabled. This mode is also used during machine and resolver calibrations.

Status Word - Contains status information about the channel's current configuration and operational state. You can use this information in your ladder program to determine whether the channel data word is valid.

Target Load - A reference load established by the user. Used primarily during setup to improve setup time.

Tolerance /Trend Alarm - User defined upper and lower control limits established during the sample and compare process. These limits are established on the peak load and will activate the machine stop relay when exceeded.

Tracking Alarm - Requires resolver input. The sample and compare process is applied to the entire forming force based on user selected upper and lower control limits.

Trend Deviation - Percent of change, high and low, from sample value to current value.

TSM - Acronym for Through-the-Stroke load monitoring. Resolver input is required for monitoring the load being developed during machine cycle.

Common Techniques Used in this Manual

The following conventions are used throughout this manual:

- Bulleted lists such as this one provide information, not procedural steps.
- Numbered lists provide sequential steps or hierarchical information.

Product Support

Contact your Helm representative or call Helm direct at 419/893-4356:

- sales and order support
- product technical training
- warranty support
- support service agreements

Your Questions or Comments on this Manual

If you have any suggestions for how this manual could be made more useful to you, please send us your ideas.

Chapter 1

Overview

You have just purchased the most advanced strain monitoring solution available. HELM INSTRUMENT COMPANY, INC. manufactures a complete line of strain monitoring control solutions for use on metal stamping, forging, compaction and assembly presses; cold forming, cold heating, injection molding and die cast machines.

At HELM, quality is inherent not only in the design of our products but in the attitudes of our employees as well. We're working together to give you the best. After all, that's what our business is all about - providing innovative instrumentation to help make your manufacturing process more productive and your operation more effective.

The Helm HM-2-SSI combines machine and tooling monitoring with programmable limit switch function. User programmable high and low limits protect the machine and tooling to ensure part quality.

Strain Gain Transducer Operation

The primary part of the load monitoring system centers around the measurement. The basic function of the Helm Strain Gain sensor is to detect the amount of deflection imposed on the press or die as parts are being formed. All Strain Gain sensors are matched to within 1% and therefore can be replaced without recalibration of the machine.

The Helm Strain Gain sensors can be mounted to strategic high stress areas of the machine frame or strategically located in tooling or applied to stop blocks. Signals from these sensors are routed to the HM-2-SSI module for processing. The Helm Strain Gage is capable of measuring either a tension or compression signal.

HM-2-SSI Features

- Two channel Strain Gage input with Auto Zero (350-700 ohm)
- PROFIBUS DP slave
- DIN rail mount
- Peak models
- Pre-programmed screens for Siemens HMI's
- Applications include Stamping, Forging, Die Cast, Injection Molding, Assembly and Weigh Scale

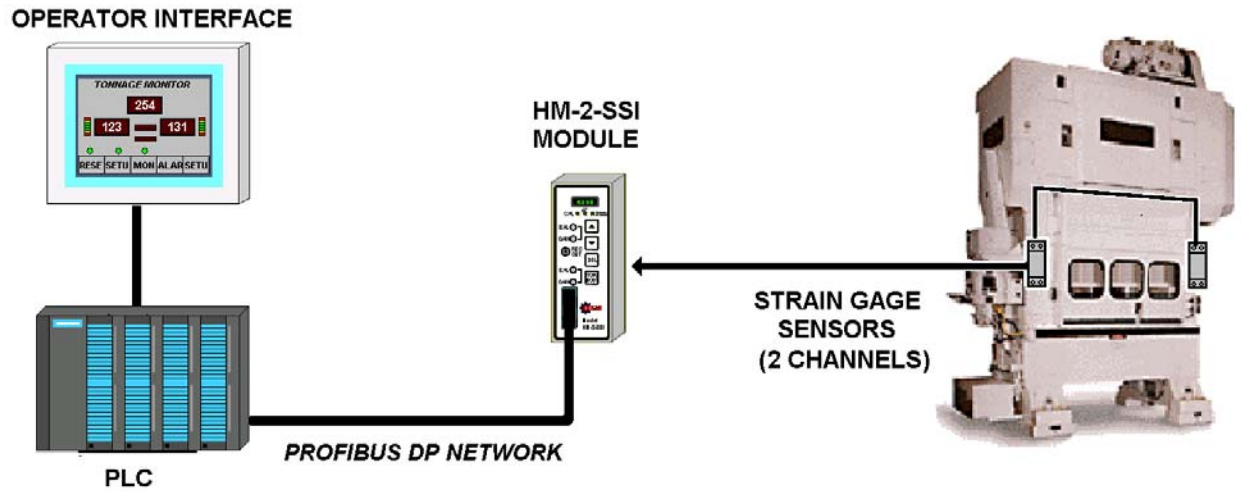

Hardware Overview

The force module uses Profibus communications. It interfaces to strain gage based transducers (350ohm or 700ohm).

The HM-2-SSI module receives and stores digitally converted analog data into its image table for retrieval on a Profibus network. The module supports connections from two strain gage sensors.

Hardware Features

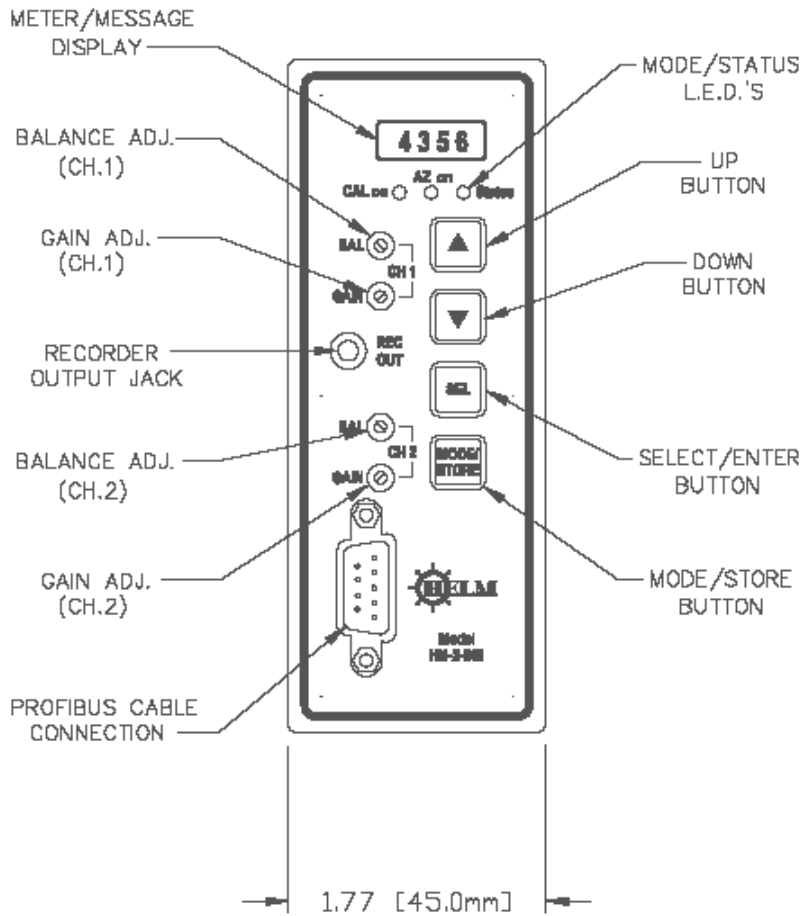

METER/MESSAGE DISPLAY:

- The message display shows menu settings, and calibration values.

BALANCE ADJ. (CH. 1):

- Used to set CH. 1's amplifier to 0.

GAIN ADJ. (CH. 1):

- Used to adjust CH.1's calibration number or gain value.

RECORDER OUTPUT JACK:

- The recorder output jack outputs the analog signals of CH. 1 and CH. 2.

BALANCE ADJ. (CH. 2):

- Used to set CH. 2's amplifier to 0.

GAIN ADJ. (CH. 2):

- Used to adjust CH.2's calibration number or gain value.

PROFIBUS CABLE CONNECTION:

- Profibus communication jack

MODE STATUS LED'S:

- **Calibration LED**
 - o This LED is lit if the module's calibration resistor is on.
- **AZ**
 - o This LED is lit when Auto-Zero (AZ) is turned on.
- **Status**
 - o Solid Green → Online Profibus Communications
 - o Flashing Green → Offline Profibus Communications
 - o Solid Red → ERROR: Profibus Communication Fault

UP/DOWN BUTTONS:

- The up/down buttons are used to change settings and values.

SELECT/ENTER BUTTON:

- This button allows the user to navigate through the menu.

MODE/STORE BUTTON:

- This button turns Calibration Mode on and off.
- When in other settings, this button is used to save the current values to the module's EEPROM.

Chapter 2

Getting Started

This chapter can help you to get started using the Helm HM-2-SSI module. The procedures included here assume that you have a basic understanding of Profibus communications. You should understand electronic process control and be able to interpret the ladder logic instructions required to generate the electronic signals that control your application.

Because it is a start-up guide, this chapter does not contain detailed explanations about the procedures listed. It does, however, reference other chapters in this book where you can get more information about applying the procedures described in each step.

If you have any questions or are unfamiliar with the terms used or concepts presented in the procedural steps, always read the referenced chapters and other recommended documentation before trying to apply the information.

This chapter will:

- tell you what equipment you need
- explain how to install and wire the module
- show you how to set channels for the sensor input

Required Tools and Equipment

Have the following tools and equipment ready:

- small blade screwdriver
- potentiometer trimmer (tweezer)
- appropriate strain gage cable

System Operation

The HM-2-SSI module communicates to a PLC through Profibus and receives +24Vdc power from an external power supply.

Each individual channel on the module can receive input signals from strain gage based sensors. The module converts the analog values directly into digital values.

Sensor Wiring

The module contains an 8-pin orange connector for wiring to the strain gages or load cells. The pin-out is shown below for both types used.

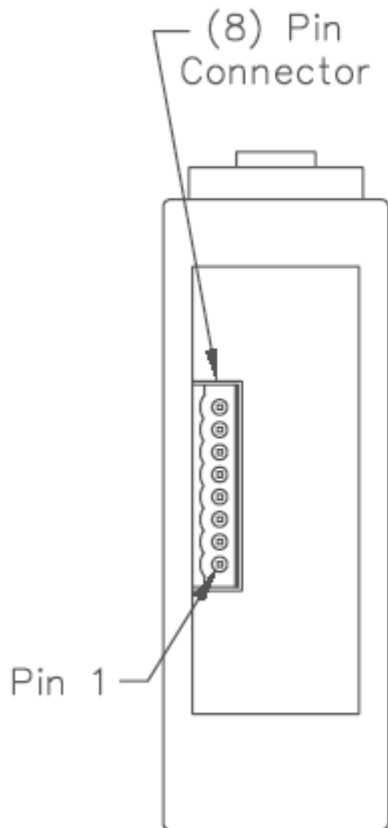

(8) PIN CONNECTOR		
PIN	COLOR	FUNCTION
1	WHITE	+SIG. CH1
2	———	SHIELD
3	RED	-SIG. CH1
4	GREEN	+GAGE
5	BLACK	-GAGE
6	WHITE	+SIG. CH2
7	———	SHIELD
8	RED	-SIG. CH2

Chapter 3

Channel Configuration Data and Status

This chapter explains how the HM-2-SSI module communicates through the module's input and output image using Profibus. It lists the preliminary setup and operation required before the module can function.

Output Image Block

SSI-2 PLM OUTPUT BLOCK (DB2)

This data block is the image of the output of the module. You can control the behavior of the module from this area such as setting the tonnage alarm limit values, changing the module's mode of operation, and etc.

Block: DBDB2	Data Type	Bit	Description
+0.0	Bit	0	Alarm Reset
+0.1	Bit	1	
+0.0	Bit	2	
+1.0	Bit	8	Set Calibrate mode
+1.1	Bit	9	Set Setup mode
+1.2	Bit	10	Set Monitor Mode
+1.3	Bit	11	
+2.0	INT	-	spare
+4.0	INT	-	Set Ch1 High Capacity Alarm Value (in Calibrate mode)
+6.0	INT	-	Set Ch2 High Capacity Alarm Value (in Calibrate mode)
+8.0	INT	-	Set Sample Count (2, 4, 8, or 16)
+10.0	INT	-	Set Low Alarm Inhibit Count
+12.0	INT	-	Set Ch1 Low Tolerance value
+14.0	INT		Set Ch1 High Tolerance value
+16.0	INT		Set Ch2 Low Tolerance value
+18.0	INT	-	Set Ch2 High Tolerance value
+20.0	Bit	0	Set Trend Alarm On/Off switch bit
+20.1	Bit	1	
+20.2	Bit	2	
+20.3	Bit	3	
+20.4	Bit	4	
+20.5	Bit	5	
+20.6	Bit	6	
+20.7	Bit	7	
+21.0	H Byte	-	Set Tolerance value type (1 = Tolerance in Ton, 0 = Tolerance in Percent)

Alarm Reset Bit

Set this bit On(1) for at least 50ms or longer to clear all present alarm condition of the module.

Set Calibrate Mode Bit

When set On (1), the module is in calibration mode. No alarms are active.

Note: all other mode bits must be off.

Set Peak Mode Bit

When set On (1), the module is in setup mode. Capacity alarms are active.

Note: all other mode bits must be off.

Set Monitor Parts Mode Bit

When set On (1), the module is in monitor parts (trend monitoring) mode. Capacity alarms and trend alarms are active.

Note: all other mode bits must be off.

Set Scale Value

This is the maximum load rating of the machine per channel. For example, if the machine is rated at 500 ton max and two load sensors are installed for the module, then the scale set should be 250.

Set Ch1(2) High Capacity Alarm Value

Integer value of high capacity alarm setting. Range = 0 to 9999. A value of 0 disables alarm.

The value entered will not be valid in the module until in Calibrate mode.

Set Sample Count

Enter one of the numbers (2, 4, 8, or 16). This is the number of cycles for the module to take to learn new sample(Target) tonnage for Trend alarm feature.

Set Low Alarm Inhibit Count

Enter a number of cycles for module to inhibit low trend alarm when sampling is done in Monitor mode. To disable this feature, enter '0'.

Set Ch1(2) High/Low Tolerance Value

Integer values of high and low limit for trend alarm settings. Values are set in percent or in ton and represent the maximum and minimum percent/ton of change off the sample value. Range = 0 to 99% or 0 to 255ton. A value of 0 disables alarm.

Set Trend Alarm On/Off switch bit

When set on (1), Trend alarm is active in Monitor part. Set off to disable it.

Set Tolerance value type bit

When set on(1), the module takes the High/Low Tolerance value setting as ton. When set off(0), the module takes the High/Low Tolerance value setting as percent.

Input Image Block

SSI-2 PLM INPUT BLOCK (DB1)

This data block is an image of the Input of the module. You can monitor the status of the module's operation from this area such as current tonnage readings, tonnage alarm conditions, reverse load readings, etc.

Block: BD DB1	Data Type	Bit	Description
+0.0	INT	-	Update Counter
+2.0	INT	-	ASIC Fault Code
+4.0	INT	-	Ch1 Peak value in Ton (in PEAK or MONITOR Mode) Ch1 Calibrate number (in CALIBRATE Mode)
+6.0	INT	-	Ch2 Peak value in Ton (in PEAK or MONITOR Mode) Ch2 Calibrate number (in CALIBRATE Mode)
+8.0	INT	-	Ch1 Trend deviation in Percent or Ton
+10.0	INT	-	Ch2 Trend deviation in Percent or Ton
+12.0	INT	-	Ch1 Sample value in Ton
+14.0	INT	-	Ch2 Sample value in Ton
+16.0	INT	-	Ch1 Reverse Load in Ton
+18.0	INT	-	Ch2 Reverse Load in Ton
+20.0	Bit	0 1 2 3 4 5 -	Ch1 High Trend Alarm Indication Bit Ch1 Low Trend Alarm Indication Bit Ch2 High Trend Alarm Indication Bit Ch2 Low Trend Alarm Indication Bit Ch1 Capacity Alarm Indication Bit Ch2 Capacity Alarm Indication Bit
+22.0	Bit	0 1 2 3 4 5 6	Module In Calibrate Mode Indication Bit Module In Peak Mode Indication Bit Module In Monitor Mode Indication Bit Sampling in progress Indication Bit Sample Ready Indication Bit (stay On until the mode changes) Alarm Rest in progress bit CAM Trigger toggle bit
+24.0	INT	-	Cycle Counter
+26.0	INT	-	CAM Signal

Update Counter

This counter increments when the data block has been refreshed (updated).

ASIC Fault Codec

Reserved for firmware trouble shoot.

Ch1(2) Peak value in Ton / Calibrate number

This integer word represents the peak load on channel 1(2) in Peak and Monitor Mode. In Calibrate mode, this displays the sensor's balance reading or calibration(gain) readings.

Ch1(2)Trend Deviation in Percent or Ton

This integer word represents the difference between current peak load and sample peak load, in percentage or tonnage. This value can be used to control Trend deviation LED type display (Only valid in Monitor mode).

Ch1(2) Sample value in Ton

This integer word represents the average of the load values in Tons when learning(sampling) cycle is completed in Monitor mode.

Ch2 Reverse Load in Ton

Integer word represents the peak reverse load value in tons for the current machine cycle.

Capacity Alarm Indication Bit

When on (1), the current peak tonnage of the channel has met or exceeded the Capacity alarm set limit.

High Trend Indication Alarm Bit

When on (1), the current peak tonnage has met or exceeded the high tolerance percentage or tonnage setting from the sample tonnage.

High Trend Indication Alarm Bit

When on (1), the current peak tonnage has met or become below the low tolerance percentage or tonnage setting from the sample tonnage.

Module In Calibrate Mode Indication Bit

This bit is reported by the module that it is actually in Calibration mode when On(1).

Module In Peak Mode Indication Bit

This bit is reported by the module that it is actually in Peak mode when On(1).

Module In Monitor Mode Indication Bit

This bit is reported by the module that it is actually in Monitor mode when On(1).

Sampling in progress Indication Bit

This bit is reported by the module that it is currently in learning(sampling) mode when On(1).

Sample Ready Indication Bit (stay On until the mode changes)

This bit is reported by the module that it completed the learning cycle and established new sample tonnage when On(1).

Alarm Reset in Progress Bit

This bit is reported by the module that it is currently resetting all alarm conditions when On(1).

CAM Trigger Toggle Bit

This bit toggles between 0 and 1 when there is a state change of the CAM input from low to high. If there is no CAM input state change, the bit remains the same as the last bit's state.

Chapter 4

Initial Hardware Setup Procedures

A complete listing of a sample Siemen's ladder logic program is included at the back of this manual. Examples shown here are for reference.



All values are 0 (default) on initial start-up. This means that all alarms are disabled. You must make the following adjustments for proper operation:

- set station number
 - set hi/low
 - set scale value
 - set auto zero (az) control
 - set channel 1 calibration
 - set channel 2 calibration
-

Steps 1 through 4 can be done if the Profibus communication is online or offline, while the steps following 1 through 4 must be done with online Profibus communications.

Menu Sequence:

1. ch1 cal (default on power-up)
2. ch2 cal
3. station
4. hi / lo
5. scale
6. az
7. module mode
8. zero (factory adjust only)

Step 1. Set the Station Number

- ⇒ From the HM-2-SSI module, press SELECT until “station” scrolls across the display. From this menu you can change the station number by pressing the up/down buttons to coordinate with the Profibus communications.

Step 2. Set the Hi/Low Gain Range

- ⇒ Press SELECT until “hi/low” scrolls across the display. Change the module’s hi/low alarm settings from here.
- ⇒ LOW = 140k CAL resistor range.
- ⇒ HI = 1M CAL resistor range.

Step 3. Set the Scale Value

- ⇒ Press SELECT until “scale” scrolls across the display. Use the up/down buttons to set the scale value to coordinate with the tonnage of the press the module is communicating with.

Step 4. Auto-Zero (AZ) Control

- ⇒ Press SELECT until “az” scrolls across the display. The auto-zero value is normally set to ‘on’. Set to ‘off’ only on special circumstances.

Step 5. Click on Calibration Mode

- ⇒ Using the software operator interface, click on Calibration Mode to put the HM-2-SSI module into Cal Mode so calibration can be completed.

Step 6. Confirm that Profibus Communications are Online (Solid Green Status LED)

- ⇒ Using the software operator interface, click on Calibration Mode to put the HM-2-SSI module into Cal Mode so calibration can be completed.

Step 7. Calibrate Channel 1

- ⇒ Press SELECT until “ch1 cal” scrolls across the display. Under this menu, users can change three values: balance value, calibration value, and az value.
 - ⇒ Balance Mode → using the balance potentiometer, you can manually adjust the balance to zero.
 - ⇒ Calibration Mode → using the gain potentiometer, a user can manually adjust the setting to their desired calibration number.
 - ⇒ Auto-Zero Mode → when AZ is turned on, this Mode will automatically zero this value.

Step 8. Calibrate Channel 2

- ⇒ Repeat Step 6 using ‘ch2 cal’.

Install GSD File Procedures

- Step 1. Begin by opening up SIMATIC Manager.
- Step 2. In SIMATIC Manager, click File → New.
- Step 3. Type gsdinstall for the project name, and click OK.
- Step 4. From the menu toolbar, click Insert → Station → SIMATIC 300 Station.
- Step 5. Double click SIMATIC 300 → Hardware.
- Step 6. From the menu toolbar, click Options → Install GSD File.
- Step 7. Browse to locate the .gsd file, and click install, then OK, and then Close.
 - Can be located on the installation CD provided by Helm
- Step 8. Keep SIMATIC Manager open, but close the current gsdinstall project.

Install Siemen's Ladder Logic Procedures

- Step 1. In SIMATIC Manager, click File → Retrieve → Select File → Open.
- Step 2. Accept the default directory, and click OK.
- Step 3. Click OK, then click OK to the next dialog that appears as well.
- Step 4. Double click SIMATIC 300 Station → Hardware.
- Step 5. From here, you are able to view/edit the hardware configurations of the card, by double clicking the card's bitmap.

Chapter 5

System Troubleshooting Guide

HT-400 Sensor Ohm Readings

Green-Black.....	350 ohms
Red-White.....	350 ohms
All other color combinations.....	266 ohms
All colors to Ground.....	open
Shield to Ground.....	open

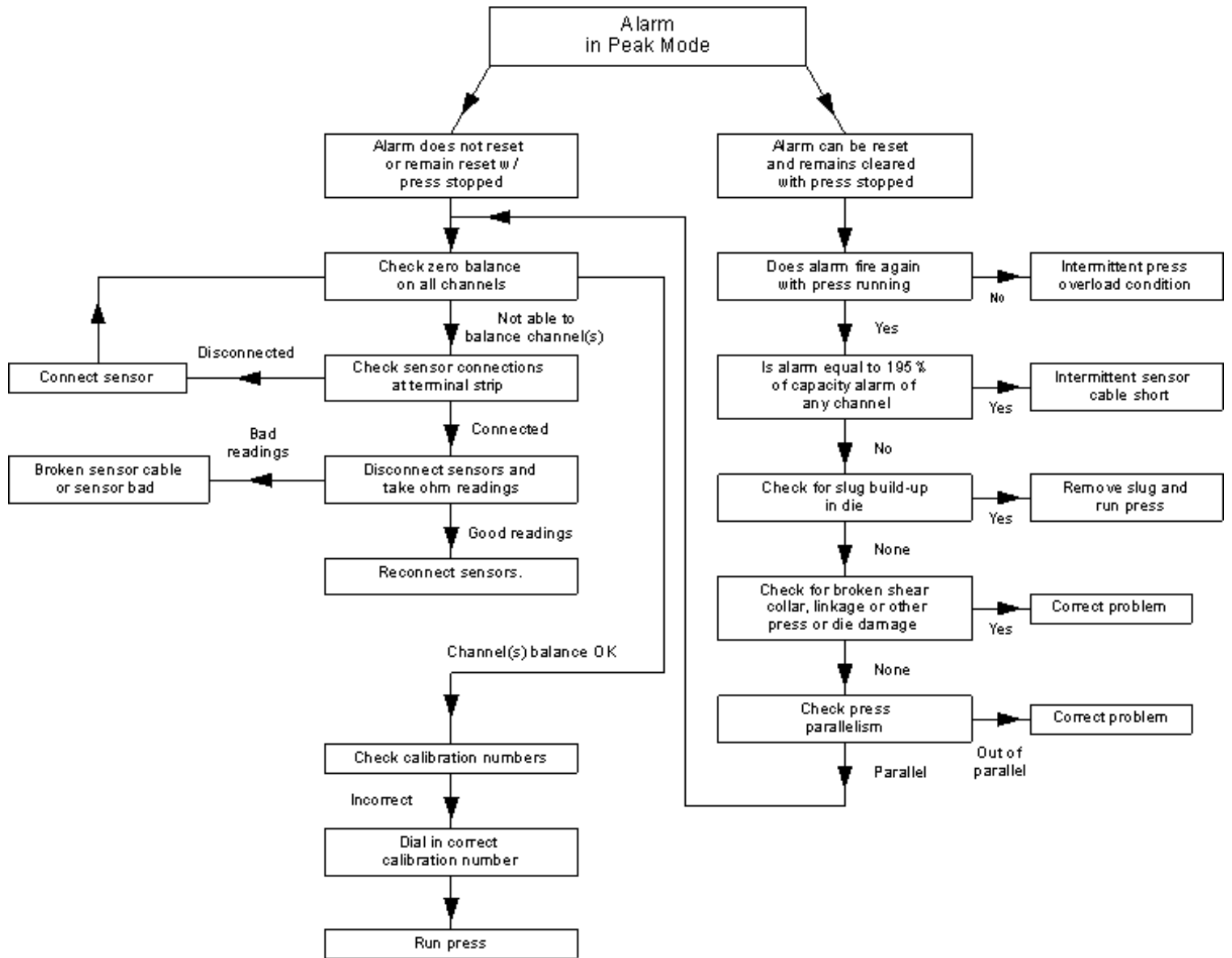

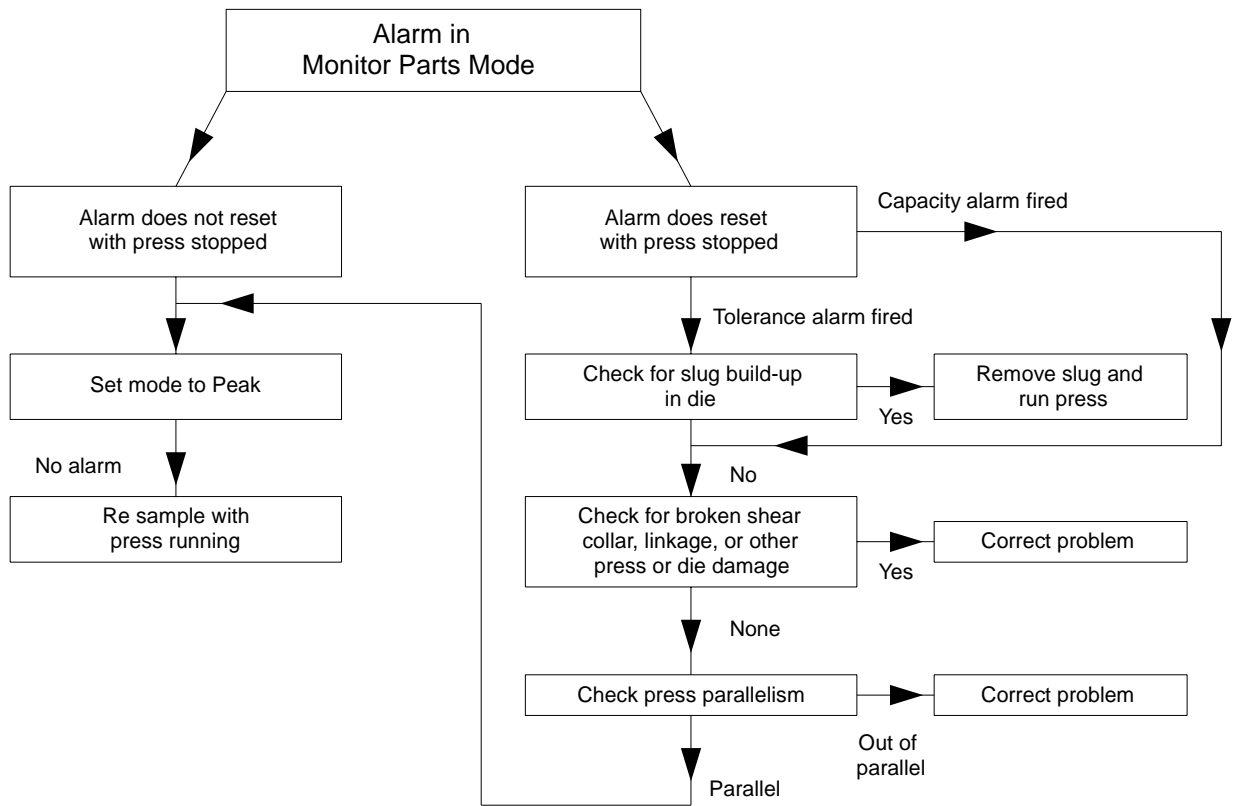

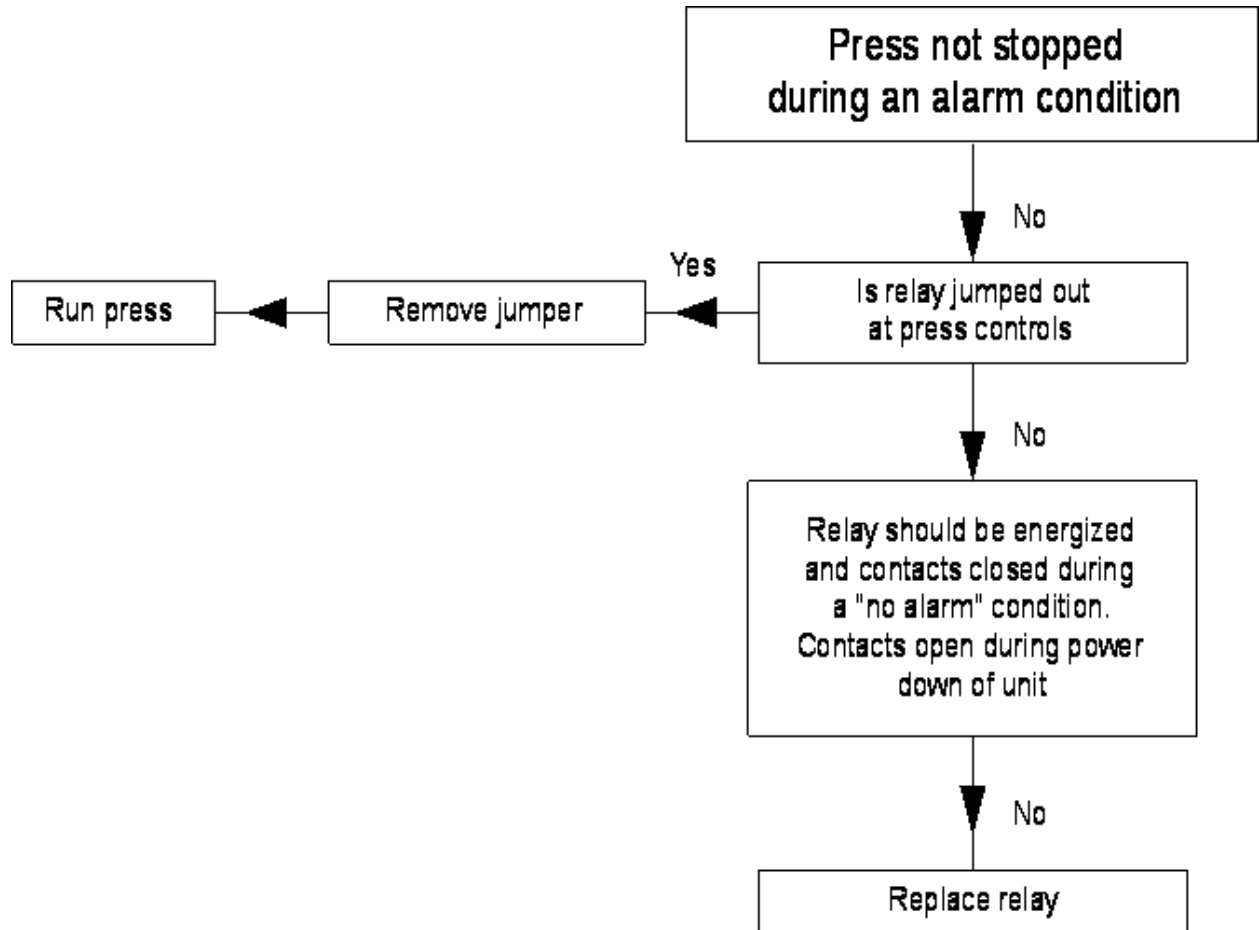

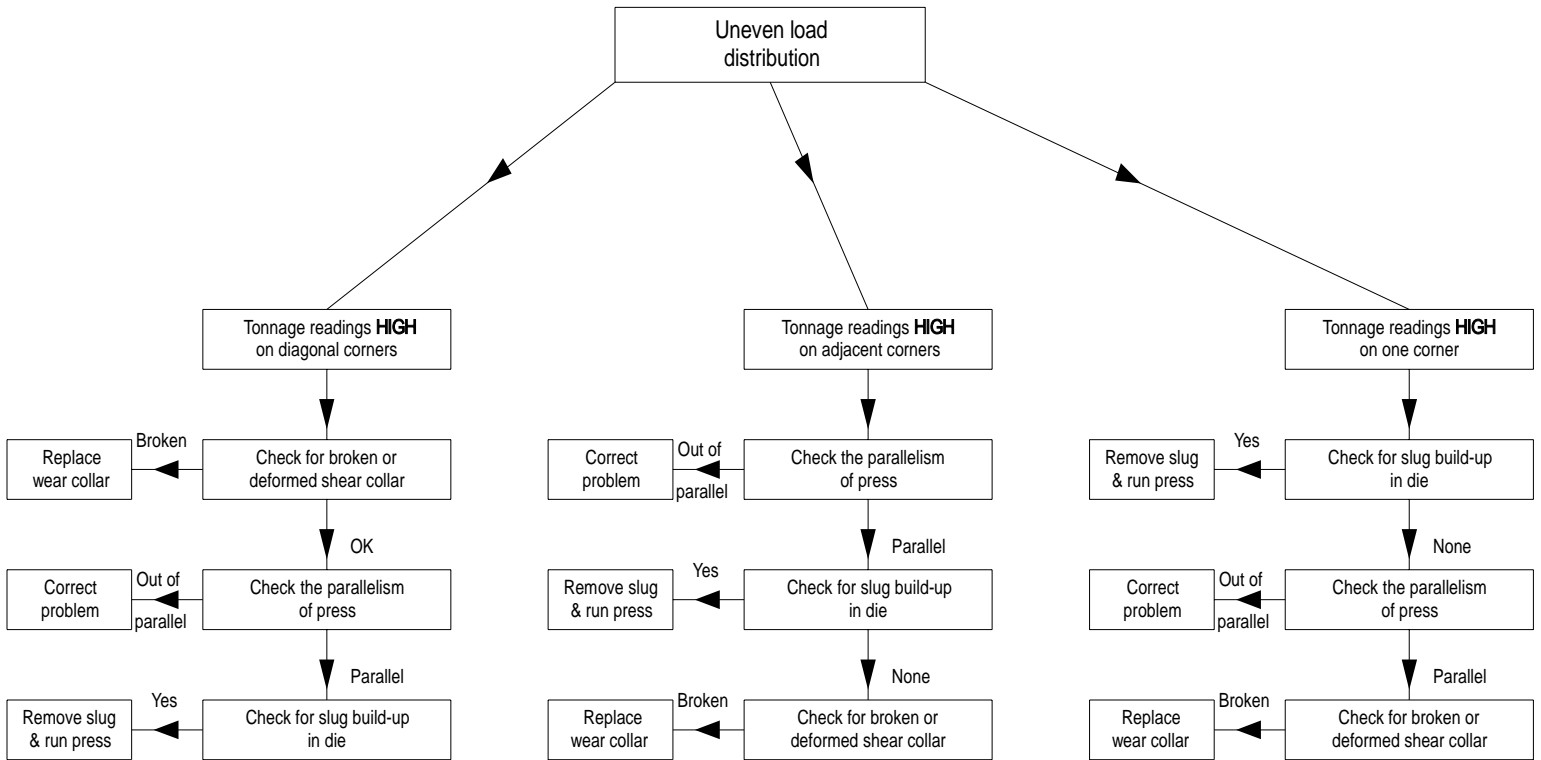

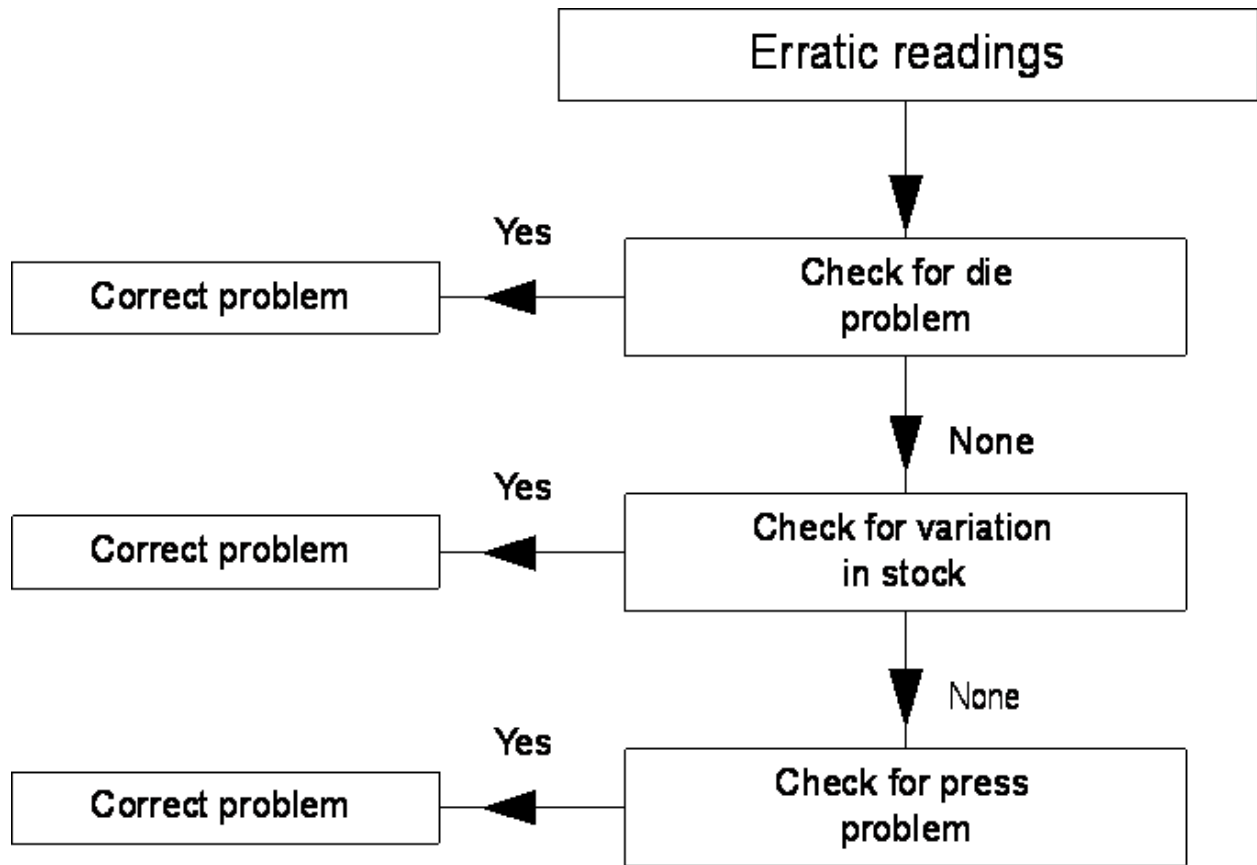

Appendix A: Specifications:

Electrical Specifications:

Power Consumption	146 MA at 24 vdc
Number of Channels	2 (isolated)
A/D Conversion Method	12 bit
Normal Mode Rejection (between + input and - input)	50 db at 2000 gain
AMP roll-off frequency	650 Hz at 3000 Gain
Calibration	Software Selectable

Physical Specifications:

Press Buttons	4 buttons for menu navigation and selection
LED Indicators	3 LEDs for Calibration, Auto-Zero, and Status
Recommended Cable	Strain Gage Cable (Helm part number 6117)
Terminal Strip	8-pin removable

Environmental Specifications:

Operating Temperature	0°C to 60°C (32°F to 140°F)
Hazardous Environment Classification	Class 1 Division 2 Hazardous Environment

Input Specifications:

Type of Input	Strain Gage (350 ohm, 700 ohm)
Input Impedance	1K
Display Resolution	Up to 0.1% of full scale
Overall Module Accuracy	1% of full scale
Module Update Time	100 μ sec

Appendix B: Module Diagrams:

HM2-SSI Load Module

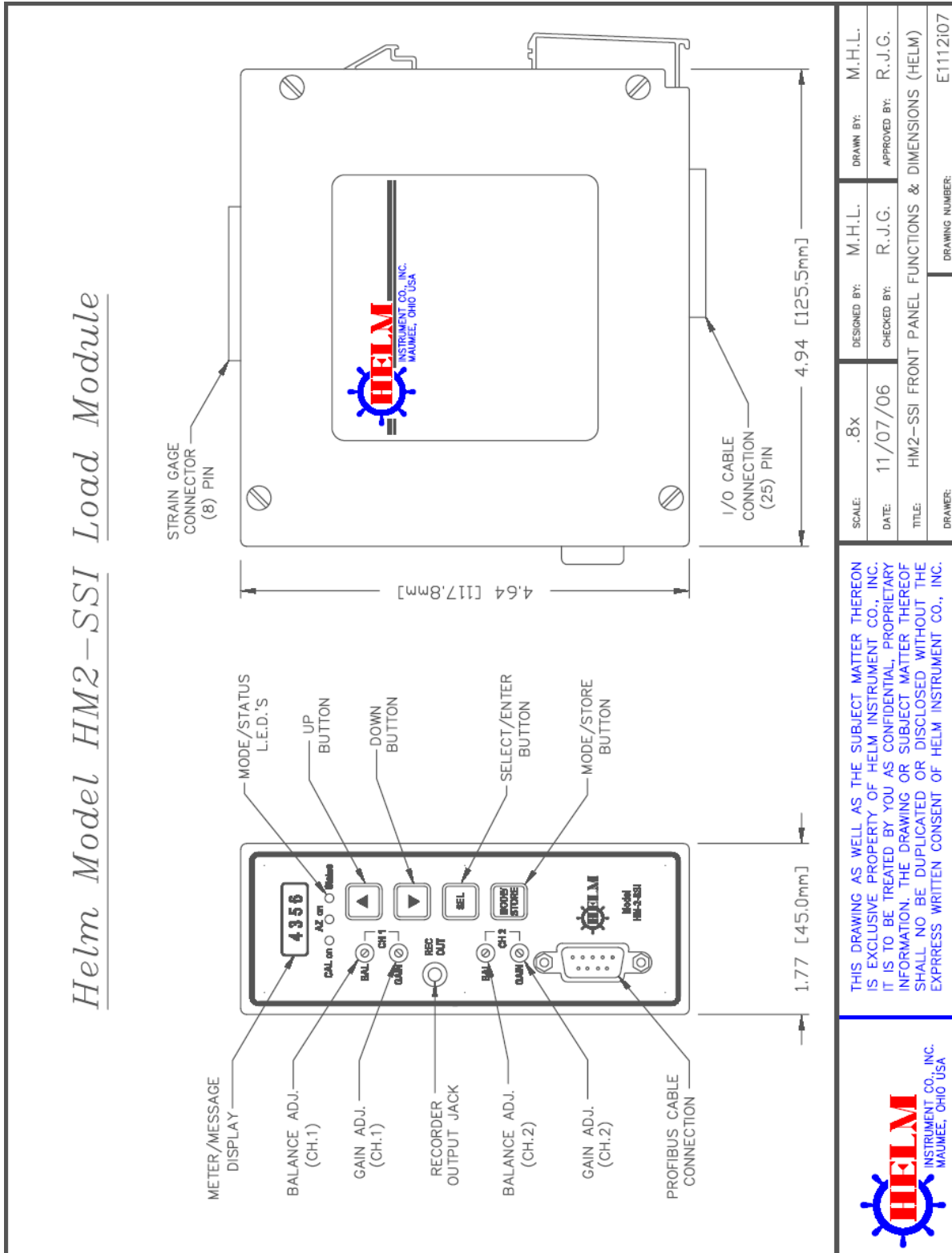

Profibus Field Wiring Diagram

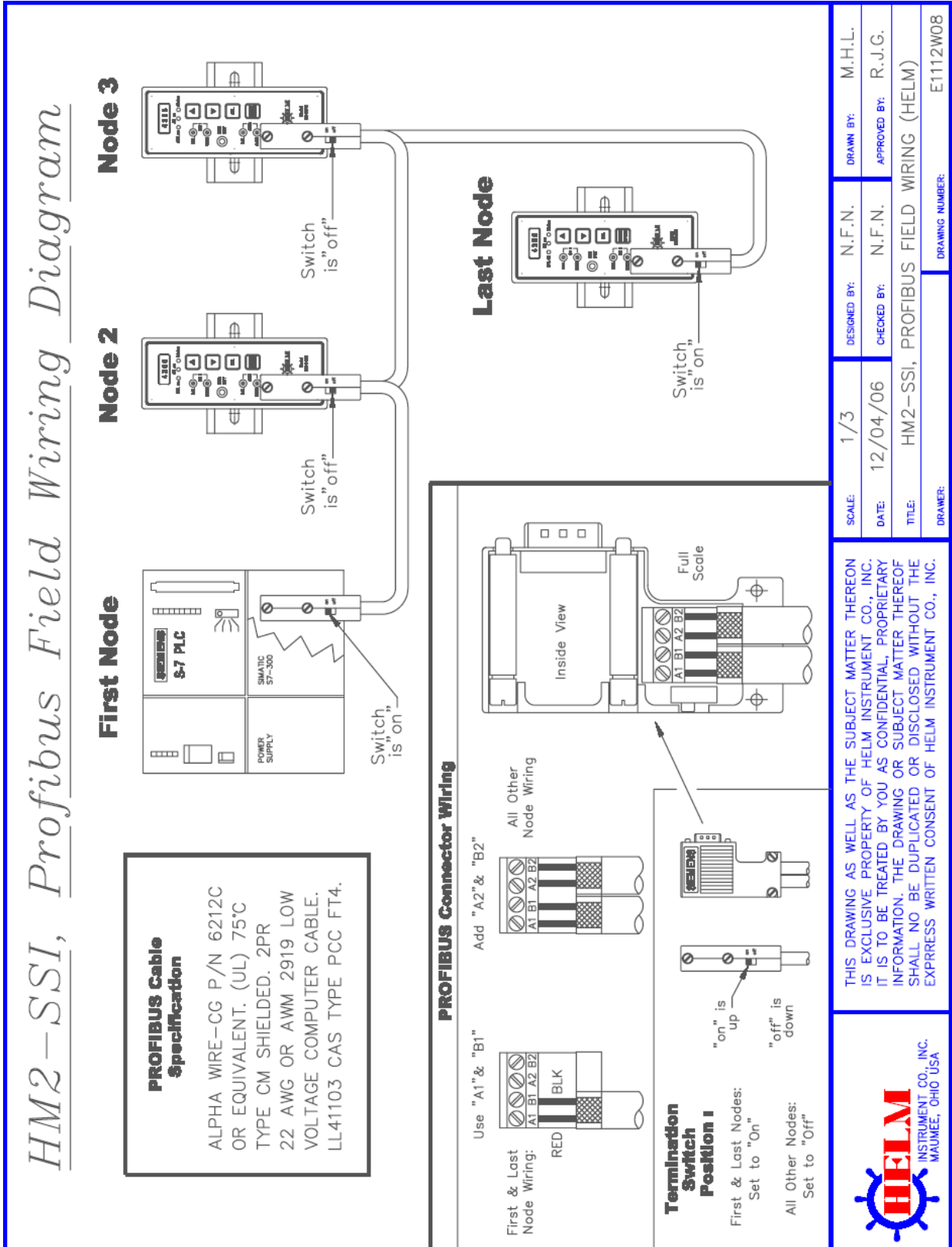

Strain Gage & I/O Connector Wiring

HM2-SSI, Strain Gage & I/O Connector Wiring

Strain Gage Connector

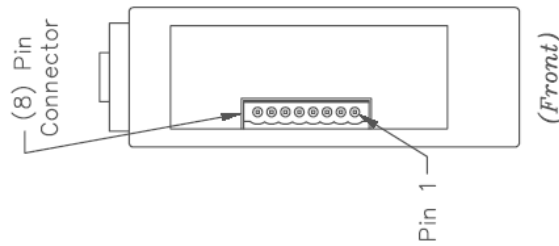

(8) PIN CONNECTOR		
PIN	COLOR	FUNCTION
1	WHITE	+SIG. CH1
2	—	SHIELD
3	RED	-SIG. CH1
4	GREEN	+GAGE
5	BLACK	-GAGE
6	WHITE	+SIG. CH2
7	—	SHIELD
8	RED	-SIG. CH2

Top View of Module

I/O Connector

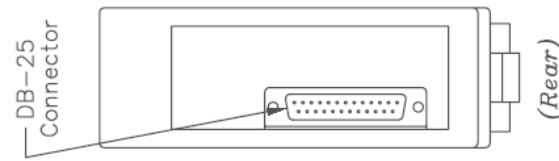

(25) PIN CONNECTOR		
PIN	COLOR	FUNCTION
1	RED	+24VDC
2	RED	+24VDC
6	BROWN	-STOP
7	ORANGE	-AUX
9	BLACK	DIG. GND
10	WHT/BRN	-CLOCK
11	GRAY	SHIELD
12	YELLOW	MSTR LATCH
13	WHT/BLUE	-DATA
14	BLACK	-24VDC
15	BLACK	-24VDC
18	GREEN	+STOP
19	BLUE	+AUX
22	WHT/YEL	+CLOCK
25	WHT/ORNG	+DATA

Bottom View of Module

THIS DRAWING AS WELL AS THE SUBJECT MATTER THEREON IS EXCLUSIVE PROPERTY OF HELM INSTRUMENT CO., INC. IT IS TO BE TREATED BY YOU AS CONFIDENTIAL, PROPRIETARY INFORMATION. THE DRAWING OR SUBJECT MATTER THEREOF SHALL NO BE DUPLICATED OR DISCLOSED WITHOUT THE EXPRESS WRITTEN CONSENT OF HELM INSTRUMENT CO., INC.



SCALE: NONE	DESIGNED BY: N.F.N.	DRAWN BY: M.H.L.
DATE: 11/29/06	CHECKED BY: N.F.N.	APPROVED BY: R.J.G.
TITLE: HM2-SSI STRAIN GAGE & I/O CONNECTOR WIRING		DRAWING NUMBER: E1112W09
DRAWER:		

I/O Wiring Connection

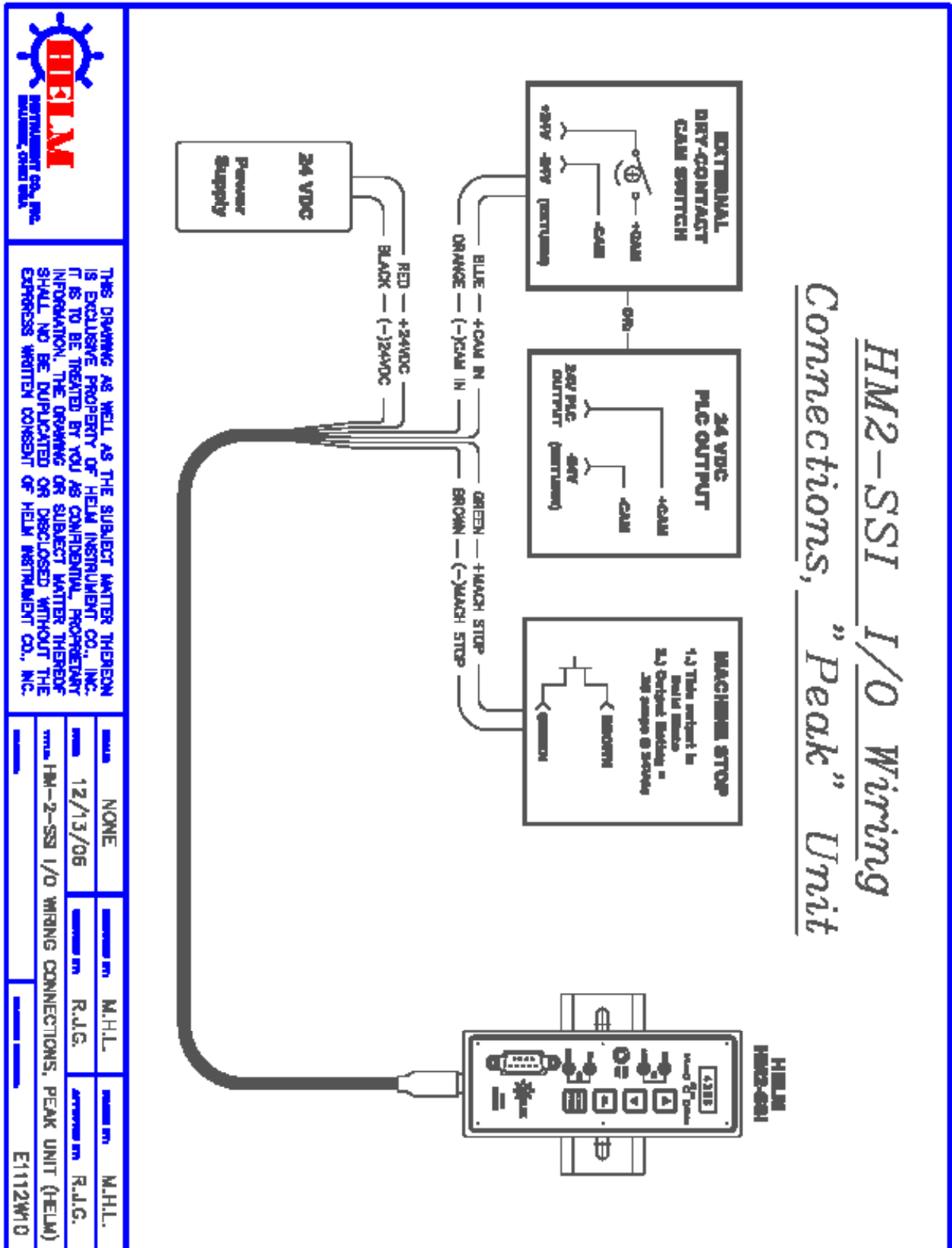

Appendix C: GSD File:

```

;-----;
; GSD PROFIBUS DP ;
; Fa. HELM INSTRUMENT COMPANY 361 West Dussel Dr. Maumee, OH 43537 ;
; Tel.: 419.893-4356 ;
; Stand: 05.12.06 ;
;-----;
#Profibus_DP
GSD_Revision=2
Vendor_Name = "HELM INSTRUMENT"
Model_Name = "SGI 2 CHANNEL"
Revision = "1.0"
Ident_Number = 0x1234
Protocol_Ident = 0 ; PROFIBUS_DP Protocol
Station_Type = 0 ; Slave-Station
Hardware_Release = "02"
Software_Release = "V3.00"
9.6_supp = 1 ; Baud rate 9.6kB
19.2_supp = 1 ; Baud rate 19.2kB
93.75_supp = 1 ; Baud rate 93.75kB
187.5_supp = 1 ; Baud rate 187.5kB
500_supp = 1 ; Baud rate 500kB
1.5M_supp = 1 ; Baud rate 1.5MB
3M_supp = 0 ; Baud rate 3MB
6M_supp = 0 ; Baud rate 6MB
12M_supp = 0 ; Baud rate 12MB
MaxTsdr_9.6 = 60
MaxTsdr_19.2 = 60
MaxTsdr_93.75 = 60
MaxTsdr_187.5 = 60
MaxTsdr_500 = 100
MaxTsdr_1.5M = 150
MaxTsdr_3M = 250
MaxTsdr_6M = 450
MaxTsdr_12M = 800
Bitmap_Device = "Helmn"
Implementation_Type = "SPC3" ; ASIC SPC3
;OrderNumber="A2000 L2"
Freeze_Mode_supp = 0 ; Freeze Mode
Sync_Mode_supp = 0 ; Sync Mode
Auto_Baud_supp = 1 ; Auto-Baud Rate
Set_Slave_Add_supp = 0
Min_Slave_Intervall = 1
Modular_Station = 0

```

```
0=Kompaktgerät, 1=Modular  
Max_Diag_Data_Len = 6;  
;  
;  
Module= "16Words In, 16Words Out" 0x5f,0x6f  
EndModule  
;Slave_Family=3  
Slave_Family=0
```

Appendix D: Address Values:

Input Image:

Block: BD DB1	Data Type	Bit	Description
+0.0	INT	-	Update Counter
+2.0	INT	-	ASIC Fault Code
+4.0	INT	-	Ch1 Peak value in Ton (in PEAK or MONITOR Mode) Ch1 Calibrate number (in CALIBRATE Mode)
+6.0	INT	-	Ch2 Peak value in Ton (in PEAK or MONITOR Mode) Ch2 Calibrate number (in CALIBRATE Mode)
+8.0	INT	-	Ch1 Trend deviation in Percent or Ton
+10.0	INT	-	Ch2 Trend deviation in Percent or Ton
+12.0	INT	-	Ch1 Sample value in Ton
+14.0	INT	-	Ch2 Sample value in Ton
+16.0	INT	-	Ch1 Reverse Load in Ton
+18.0	INT	-	Ch2 Reverse Load in Ton
+20.0	Bit	0 1 2 3 4 5 -	Ch1 High Trend Alarm Indication Bit Ch1 Low Trend Alarm Indication Bit Ch2 High Trend Alarm Indication Bit Ch2 Low Trend Alarm Indication Bit Ch1 Capacity Alarm Indication Bit Ch2 Capacity Alarm Indication Bit
+22.0	Bit	0 1 2 3 4 5 6	Module In Calibrate Mode Indication Bit Module In Peak Mode Indication Bit Module In Monitor Mode Indication Bit Sampling in progress Indication Bit Sample Ready Indication Bit (stay On until the mode changes) Alarm Rest in progress bit CAM Trigger toggle bit
+24.0	INT	-	Cycle Counter
+26.0	INT	-	CAM Signal

Output Image:

Block: DBDB2	Data Type	Bit	Description
+0.0	Bit	0	Alarm Reset
+0.1	Bit	1	
+0.0	Bit	2	
+1.0	Bit	8	Set Calibrate mode
+1.1	Bit	9	Set Setup mode
+1.2	Bit	10	Set Monitor Mode
+1.3	Bit	11	
+2.0	INT	-	Spare
+4.0	INT	-	Set Ch1 High Capacity Alarm Value (in Calibrate mode)
+6.0	INT	-	Set Ch2 High Capacity Alarm Value (in Calibrate mode)
+8.0	INT	-	Set Sample Count (2, 4, 8, or 16)
+10.0	INT	-	Set Low Alarm Inhibit Count
+12.0	INT	-	Set Ch1 Low Tolerance value
+14.0	INT		Set Ch1 High Tolerance value
+16.0	INT		Set Ch2 Low Tolerance value
+18.0	INT	-	Set Ch2 High Tolerance value
+20.0	Bit	0	Set Trend Alarm On/Off switch bit
+20.1	Bit	1	
+20.2	Bit	2	
+20.3	Bit	3	
+20.4	Bit	4	
+20.5	Bit	5	
+20.6	Bit	6	
+20.7	Bit	7	
+21.0	H Byte	-	
			Set Tolerance value type (1 = Tolerance in Ton, 0 = Tolerance in Percent)

Appendix E: *Siemen's Ladder Logic:*

Network 1 : INPUT IMAGE DATA BLOCK MOVES

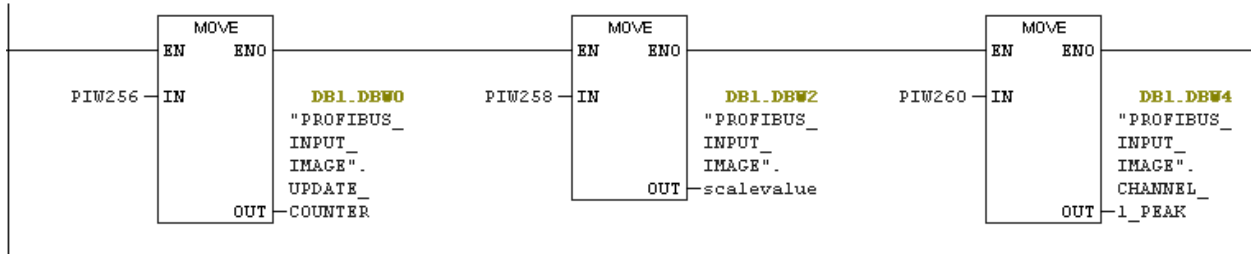

Network 2 : INPUT IMAGE DATA BLOCK MOVES

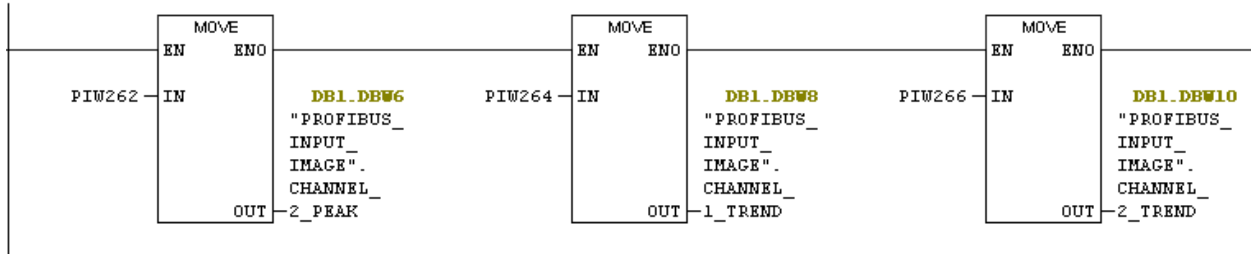

Network 3 : INPUT IMAGE DATA BLOCK MOVES

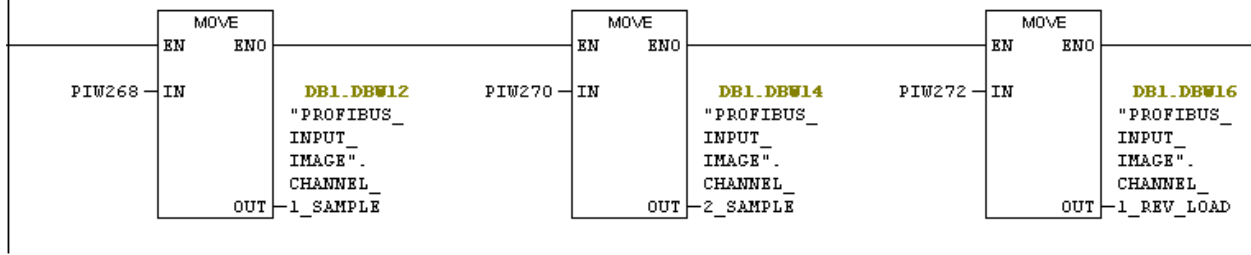

Network 4 : INPUT IMAGE DATA BLOCK MOVES

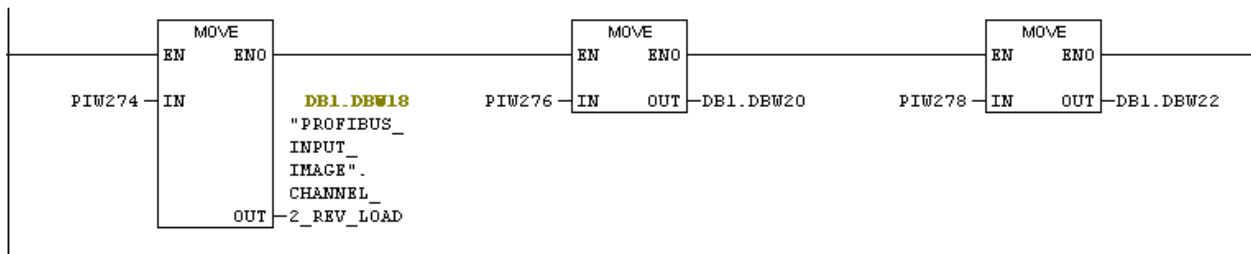

Network 5 : INPUT IMAGE DATA BLOCK MOVES

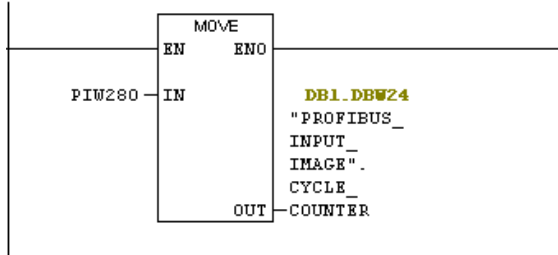

Network 6 : OUTPUT IMAGE DATA BLOCK MOVES

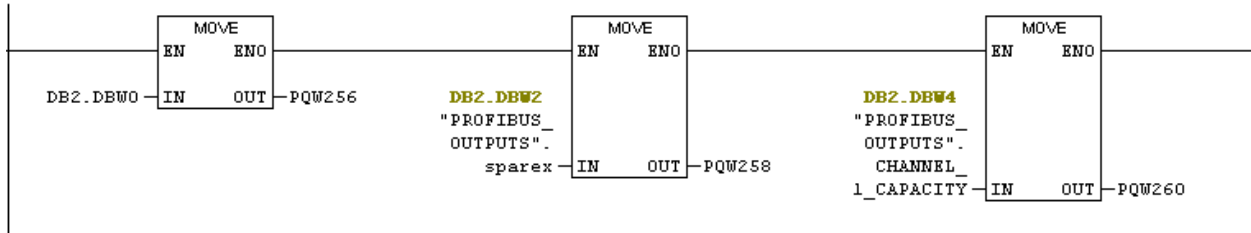

Network 7 : OUTPUT IMAGE DATA BLOCK MOVES

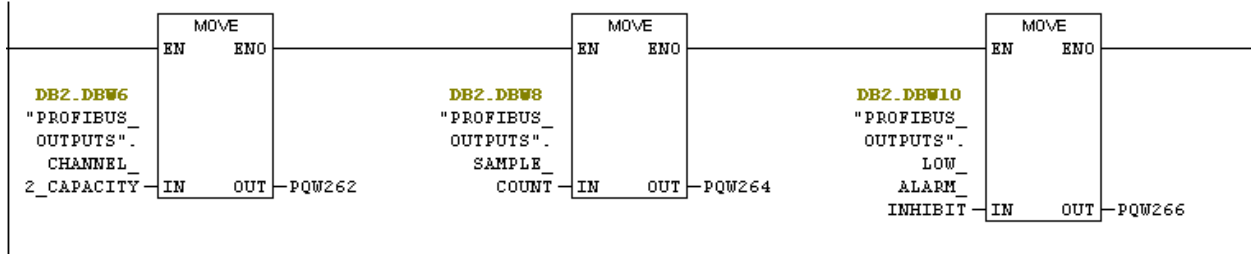

Network 8 : OUTPUT IMAGE DATA BLOCK MOVES

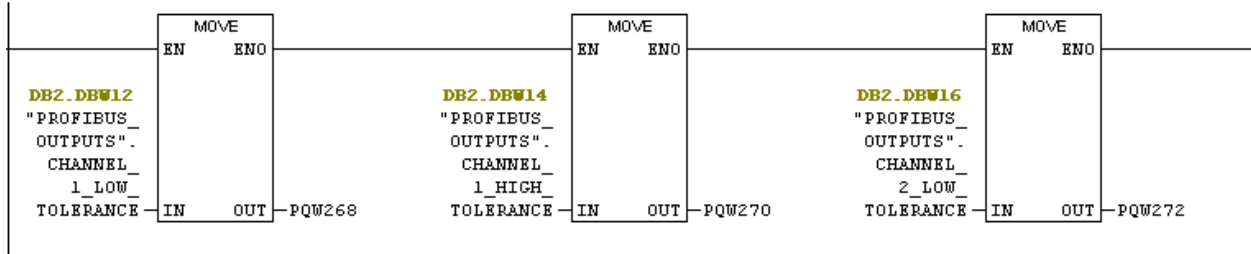

Network 9 : OUTPUT IMAGE DATA BLOCK MOVES

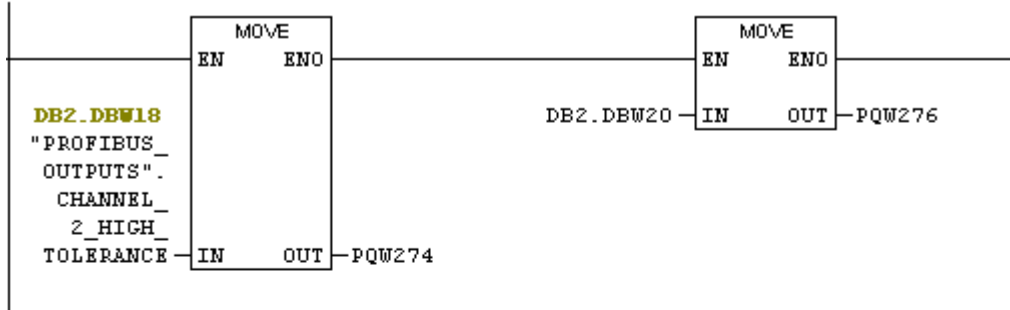

Network 10 : TOTAL TONNAGE

