



Helm Instrument Company, Inc.
361 West Dussel Drive
Maumee, Ohio 43537 USA
419/ 893-4356
Fax: 419/ 893-1371
www.helminstrument.com

TMG1200 Operating Instructions

Table of Contents

Introduction	2
Basic Operation	
Description of Component Parts	3
Normal Operation.....	6
Changing Preset Range.....	7
Operation of Counter	8
Specifications.....	9
Applied Operation	
Mean Value and Absolute Value.....	10
Details of Detection	13
Slowdown Detection	13
External Timing	13
Details of System Setting.....	14
Maintenance	
Connection of Terminal Block	16
Sensor Installation	17
Sensor Adjustment.....	18
Troubleshooting Guide.....	19

We would like to thank you for purchasing the TMG-1200 non-contact monitor. This guide consists of four parts: Introduction, Basic Operation, Applied Operation and Maintenance. Prior to operation, please read the TMG-1200 guide thoroughly.

Introduction

The TMG-1200 detects the “Front Dead Center” (FDC) positions of the cold former using a proximity sensor and sends a fault signal to the output when the difference between FDC positions at each stroke exceeds the preset range. The TMG-1200 will send a fault signal to the output when the revolutions (rpm) of the cold header or cold former fall below the preset range when slowdown detection is set to On.

Fault detection of FDC position is performed in two modes - Adaptive (mean value) comparison and Trend (absolute value) comparison. For each of these modes, it is possible to preset the operating range. Slowdown detection can be set in units of 1% in the range of -5% to -49%.

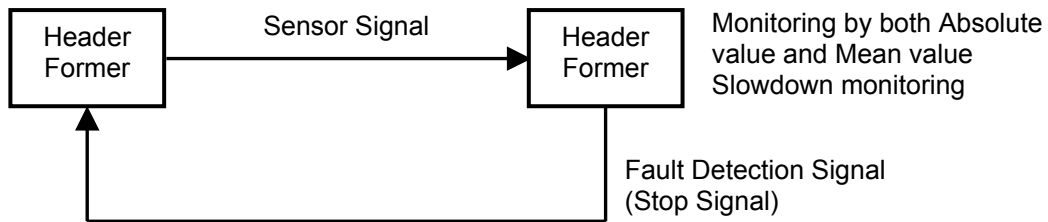

This device meets the requirements for the single, double and multi modes according to the types of cold header and cold former.

The single mode is for single stroke, single die machines.

The double mode is for single stroke, double die machines.

The multi mode is a multi-slide or progressive header (Two sensors are necessary only in the case of using the multi mode.) The TMG-1200 can be setup for operation in any of these modes. Refer to the contents of Section “System Setting”.

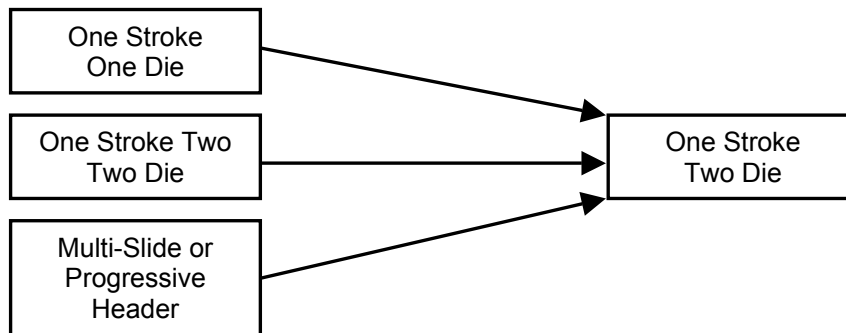

The device is factory set in the double mode. The set point setting and system setting are preset at the factory. System can start at installation.

Description of Component Parts

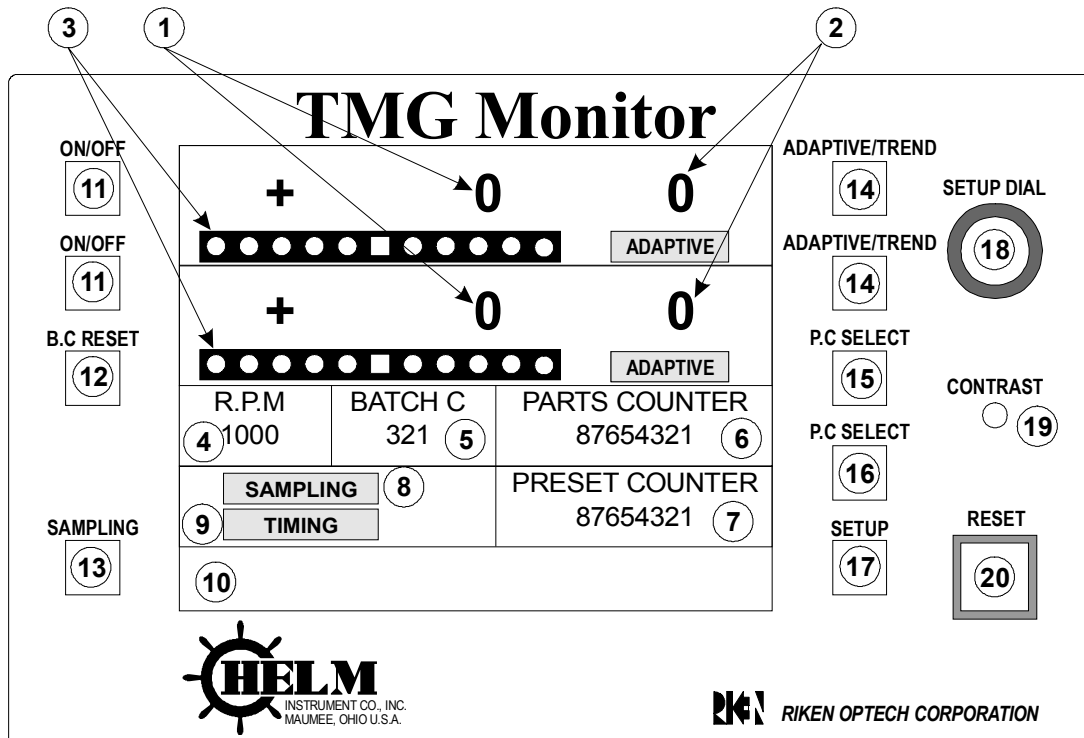

1. Deviation display (unit: μm) - Displays the deviation detected by the proximity sensor. It is factory set for adaptive (*mean value*) display.
2. Set point display - Displays the monitoring range between the upper and lower limits. When the display shows a deviation exceeding the limit values, the TMG-1200 displays a fault condition.
3. Bar display – Displays the deviation from the set point. The left side of the bar display is the “-” (negative) side of the set point and the right side the “+” (positive) side. The center square is the “0” position, and the two sides are divided each into five equal parts. For example, when the set point is 10, the display is as shown below:

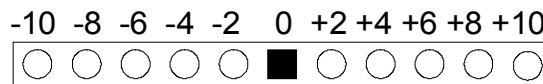

Bar Display Scale (Unit: μm)

When the set point is less than 5, the display will show 5.

The bar display during set point setting serves as a clearance gauge to indicate the FDC position (refer to section “Sensor Adjustment”).

4. RPM Display
Displays the rpm's of the cold header and cold former in real time.
5. Batch counter
A 3-digit counter which counts the number of times that the preset counter has counted up.
6. Parts counter
An 8-digit preset counter which does not perform counting while detection is off.
7. Preset counter set point
Shows the set point of the preset counter.
8. Trend value sampling display
Indicates that sampling of Trend data, for absolute value detection, is not complete or sampling is being performed.
9. External timing indicator
Indicates when the external timing is on.
10. Comment column
Shows the current fault or operational state.
11. ON/OFF button
The button to turn on or off fault detection by deviation. When fault detection is off, "OFF" is shown on the set point display.
12. Batch counter reset button
Push this button to reset the batch counter to "0".
13. Sampling button
Press Sampling button to start sampling Trend data for reference data during operation. During sampling, "Sampling" appears on the screen.
14. Adaptive/Trend button
The button to select whether to cause the deviation display to show the absolute value or mean value. Which of them is selected is indicated by "Adaptive" or "Trend" on the lower side of #2 – Set point display. The button is factory set for mean value display.
15. Preset counter reset button
Push this button to reset the preset counter to "0".
16. Preset counter select button
Push this button to set the point of the preset counter (refer to section "Operation of Counter").
17. Setup button
Push this button to change the set point (refer to section "Changing Preset Range").
18. Setup dial
Used to change the set point or to change settings in the system mode.
19. Contrast control
Used to adjust the contrast of the Liquid Crystal Display (LCD) screen. The contrast control is factory adjusted. Readjust it when the screen is difficult to see.

20. Reset button

When a fault is detected, the red lamp goes on to notify of a fault condition. Pushing this button cancels the fault condition and causes the red lamp to go off. In normal operation, pushing this button causes the red lamp to flash and turns off fault detection. Pushing it again stops flashing of the red lamp and cancels the bypass state.

Normal Operation

Normal operation does not require any special procedure. However, some procedures need to be performed when detection is by-passed for setup or for turning on/off wire feed during continuous operation. The procedures are described below.

1. At setup for material supply, etc., press the Reset button to cause the TMG-1200 to go to the by-pass state. Push the reset button again cancels the bypass state.
2. When the machine is operated in the continuous mode, the TMG-1200 automatically starts detection after 10 strokes. During the initial 10 strokes after the start of the machine, fault detection is automatically by-passed to prevent erroneous detection due to the initial instability of the machine. (The number of times that detection is turned off can be changed by system setting.)
3. When the deviation exceeds the set point during continuous operation, the TMG-1200 issues a machine stop fault condition and red lamp of the reset button goes on indicating that the machine has stopped.
4. Pushing the reset button turns off the red lamp and cancels the fault detection condition. The numerical display of abnormal value etc., is maintained as it is.
5. To change the set point, refer to the next section "Changing Preset Range".

Changing Preset Range

The set point can be changed when necessary by pushing the setup button, regardless of whether the machine is in the stop state or in continuous mode. The black and white colors on the set point display are inverted, so turn the setup dial to change the display to an arbitrary value.

In this case, "Adaptive" or "Trend" appears on the lower side of the set point display, indicating the respective set points.

Set the set point display to the display type to which you wish to change it, and then turn the setup dial.

To change from mean value (adaptive) display to Trend (absolute value) display or vice versa, push the "Absolute/Trend" button on the right side of the respective displays.

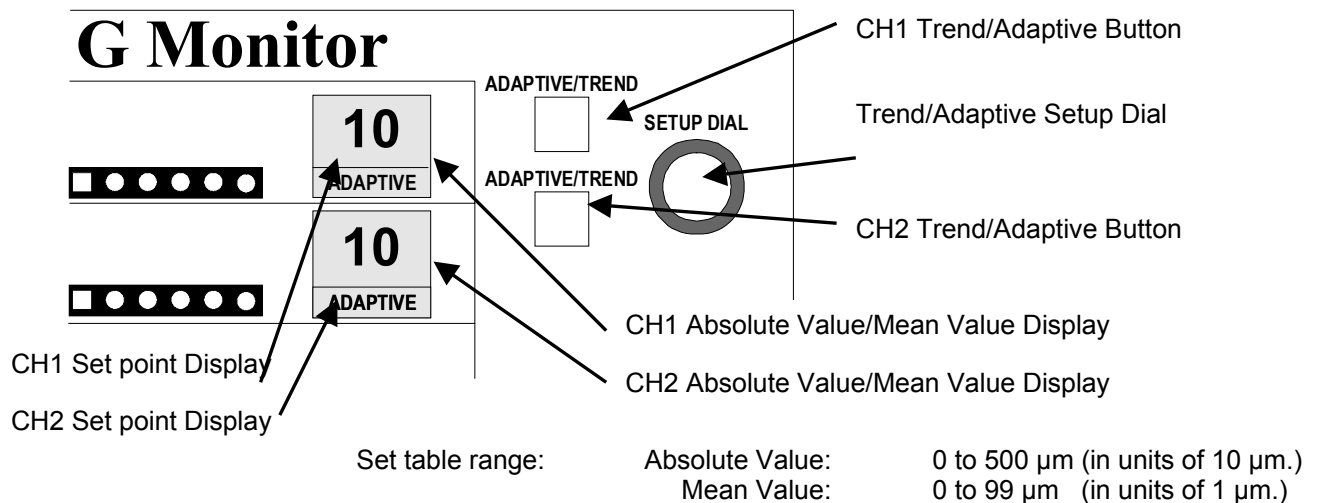

- Setting the absolute value to "0" turns off absolute value detection.

Operation of Counter

This device incorporates an 8-digit counter which uses the sensor signal to count one per stroke. The operating procedure is described below.

1. Setting of preset value
 - a) Push the counter setup button to set the device in the preset setup mode. (Black-white inversion occurs at the highest order digit of the preset set point.)
 - b) With each push of the setup button, the digit with black-white inversion shifts to the lower order, so set digits to which you wish to set the set point.
 - c) Turn the setup dial to set to an arbitrary value. Set digits one by one.
 - d) After setting all digits, don't fail to push the counter setup button and bring to the position of the digit with no black-white inversion (the position at which setting is turned off). 8th digit→7th digit→6th digit→5th digit→4th digit→3rd digit→2nd digit→1st digit→setting Off→8th digit The digit position shifts with each push of the setup button. Setting the preset set point to "0" turns off setting, so the preset counter operates as the total counter.
2. Resetting of preset counter
To reset the preset counter to "0", push the preset counter reset button. In this case, the fault output cannot be cancelled even when the fault detection signal is being output.
3. Batch counter
The batch counter is a 3-digit total counter to count the number of times that the preset counter has counted up.
4. Resetting of batch counter
When you wish to reset the batch counter to "0", push the batch counter reset button. In this case, the fault output cannot be cancelled even when the fault detection signal is being output.

Specifications

- **Power supply and output section**

Power supply	100-240 VAC, 50 or 60 Hz
Power consumption	Less than 15W
Output contact	1A-1B (fault signal output, counter signal output)
Output contact capacity less	Less than 250 VAC, less than 5A Cos Ø = 1

- **Detection section**

Number of channels	2 channels (channel 2 in case of using multi mode)
Detection range	1mm to 3mm
Repeating accuracy	1 µm
Preset range	Mean value ± 99 µm, Absolute value ± 500 µm
Sensor type	Sanksu GS-14M

- **Display section**

Display	LCD with back light (128 x 48 pixels)
Operating temperature range	0 to 50°C
Retention temperature range	-20 to 60°C
Humidity	10-0-% RH max. (wet bulb temperature shall be less than 29°C for prevention of dew condensation). Temperature compensation circuit incorporated
Contrast control	Externally attached

- **Others**

Backup	EPROM is used; backup time more than 10 years
Backup contents	All contents
Maximum speed	1,200 rpm
Operating temperature	range -10 to 50°C
Retention temperature	range -20 to 75°C
Humidity	10-85% RH max. (Wet bulb temperature shall be less than 29°C for prevention of dew condensation.)

- **Accessories**

Sensor	2 (Sanksu GS-14M)
User's guide	1

Mean Value and Absolute Value

This device is capable of performing absolute value detection and mean value detection. These detection modes are performed at the same time. For each of these modes, it is possible to set the set point individually. Details of each detection mode are given below.

- **Absolute value detection**

When the machine is operated in the continuous mode, detection is kept turned off for a while during the initial 10 strokes (the initial number of bypasses or the number of times that detection is turned off can be changed by system setting) and begins with the 11th stroke. After the end of this bypass state, sampling of reference data for absolute value detection is repeated 10 times. (The number of times that absolute value sampling is performed can be changed by system setting.) During sampling, "Sampling" appears on the left side of the screen. Mean value comparison is made during sampling. After completion of sampling the mean value of sampled data is determined as the reference value with which the subsequent data are compared at all times.

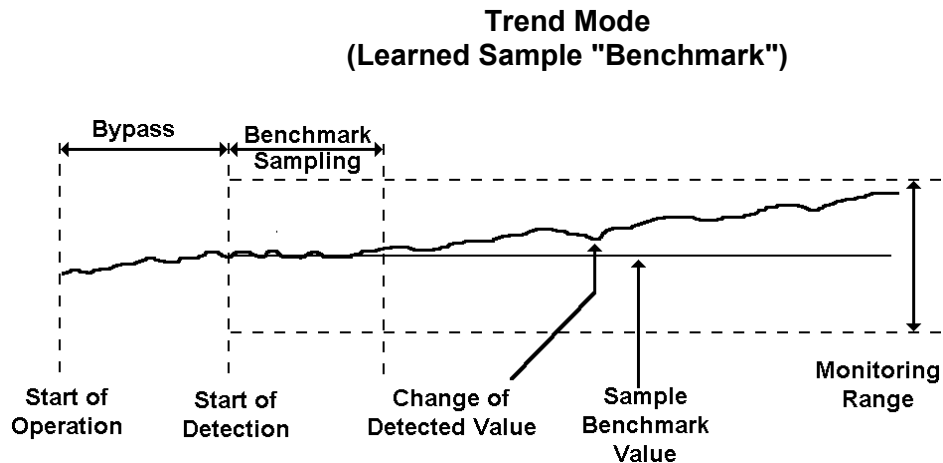

**Trend Mode
(Learned Sample "Benchmark")**

- Compares present Sensor-to-target displacement to Average of Displacement for Initial strokes during "Benchmark" sampling.
- Monitoring limits established for plus / minus deviation based on preset values
- Bypass function at start of operation inhibits alarms during machine stabilization.
- Slow changes over time NOT canceled.
- Fault detection range set wider (± 20 microns typ.) to prevent nuisance alarms.
- Changes over time detected (loss of lubrication, machine heat up / cool down, changes in material hardness, etc.)

The deviation displayed is calculated by the equation:

$$\text{Deviation} = \text{Detected Value} - \text{Reference Value}$$

Ex) Detected value: 1,823mm Reference value: 1,798mm
1,823 – 1,798 = 0.025 Display value: 25

The monitoring range depends on the set point. When the set point is 100, the monitoring range is ± 100 (m relative to the reference value. Absolute value detection is characterized in that the value right after start is taken as reference for comparison with detected values, so slow changes such as overload by temperature can be detected. To recommence sampling of reference data for absolute value detection during operation, push the sampling button. Then sampling is recommended with the appearance of "Sampling" on the left side of the screen. Mean value detection is performed during sampling.

- **Mean Value Detection**

When the machine is operated in the continuous mode, detection is kept turned off for a while during the initial 10 strokes (the initial number of bypasses the number of times that detection is turned off can be changed by system setting) and begins with the 11th stroke. Mean value detection is a detection mode which makes comparison with the mean value of 10 previous data (the number of averages taken can be changed by system setting) when the device gets into the detection condition after the end of the bypass state. However, right after the start of detection, 10 previous data are not available. Therefore, after the end of the bypass state, the 1st data is compared with the last detected value at the end of bypass, the 2nd data with the 1st detected value, the 3rd data with the mean value of the 1st and 2nd data, and the 4th data with the mean value of the 1st, 2nd and 3rd data. Thus the data up to the 10th are compared each with the mean value of previous data and the 11th and subsequent data are compared each with the mean value of 10 previous data at all times.

Adaptive Mode (Stroke-to-Stroke "Rolling Average")

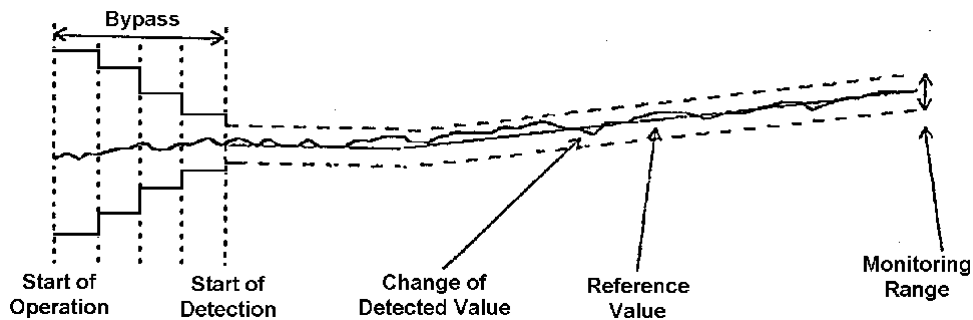

Adaptive Mode (Stroke-to-Stroke "Rolling Average")

**Adaptive Mode
(Stroke-to-Stroke "Rolling Average")**

- Compares present Sensor-to-target displacement to Mean Value of Displacement for previous two strokes.
- Monitoring limits established for plus / minus deviation.
- Bypass function at start of operation has progressively closer alarm limits during machine stabilization.
- Slow changes over time canceled.
- Fault detection range set very small (± 5 microns typ.) without nuisance alarms.
- Sudden changes (dropped parts, short feeds, chipped or broken punches) easily detected.

The deviation displayed is calculated by the equation:

$$\text{Deviation} = \text{Detected Value} - \text{Average of 10 Previous Values}$$

Ex) Detected value: 1,823mm Average of 10 previous values: 1,820mm
1,823 – 1,820 = 0.003 Display value: 3

The monitoring range depends on the set point. When the set point is 10, the monitoring range is ± 10 (m relative to the mean value of 10 previous data. Mean value detection is characterized in that slow changes are cancelled and only sudden changes such as punch abnormality, shorter size, etc., can be detected.

In addition, the detection range can be made smaller so this detection mode is suitable for minute fault detection.

Details of Detection

This device can select three detection modes. Which detection mode is to be used, depends on the type of machine.

- **Single mode**
This mode is for single stroke, single die headers. The screen display is limited to one channel only.
- **Double mode**
This mode is used for such machines which perform two work with punches 1 and 2 in one stroke. In this case, detection is made for two punches at the same time, using one sensor (2-die & 2-blow, 2-die & 3-blow). The device is factory set in this mode.
- **Multi model (multi-stage type)**
This is the detection mode for multi-stage headers and formers. Detection is performed using two sensors. With one each sensor installed at the left and right sides of the slide, fault detection is made based on the inclination of the slide.

These detection modes can be selected by system setting. (Refer to Section “Details of System Setting”.)

Slowdown Detection and External Timing

- **Slowdown detection**
The TMG-1200 has a slowdown detection function. When the rpm of the machine has decreased due to machine trouble, this function stops the machine. The rpm when the machine was started in the continuous mode is kept in memory. When the rpm becomes lower than that at the start by more than the set value, a fault signal is produced and the screen display shows that the machine has stopped due to slowdown. The function is used mainly for prevention of motor burnout. The set table range is from -5% to -49% in units of 1%. Slowdown detection is factory set in the off state. This function is set by system setting. (Refer to Section “Details of System Setting”.)
- **External timing**
This device has an external timing input. In the case of double detection, detection is made for punches 1 and 2, using one sensor. Therefore, this input is used to make it recognized by an external signal that the timing is for punch 1.

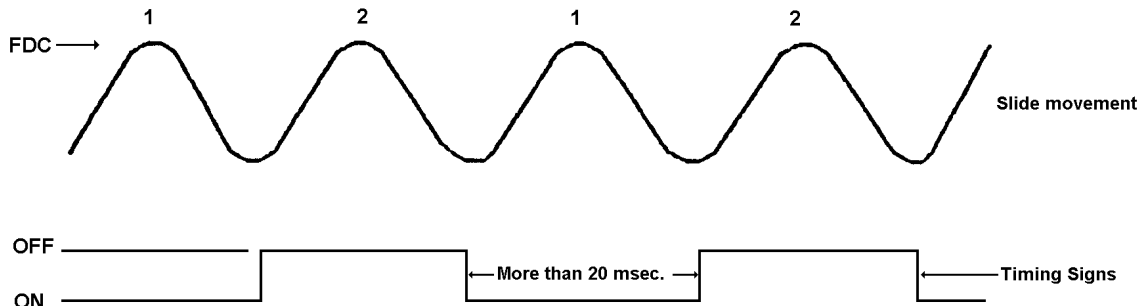

By turning on (short circuiting) the external timing input with the timing for punch 1 as mentioned above, this device discriminates between punches 1 and 2. (Set the time, during which the input stays on, to more than 20 msec.) In case punches 1 and 2 are different in load, the punch of smaller load is automatically set as punch 1, and the punch of larger load as punch 2, without connecting the timing signal.

Details of System Setting

The operation of the TMG-1200 can be varied by system setting to enable the device to be used in various ways. Being preset, system settings items do not need to be changed. How to change them is described below.

- **Starting the system setting mode:**
Push the Reset button while pushing the Setup button. The menu screen for system setting appears. There are a total of 9 menu items.
- **Changing settings**
To change settings, turn the setup dial on the menu screen to select an item to which you wish to make a change.

After selecting the item, push the reset button to obtain the data screen for the item.

When the data screen has appeared, turn the setup dial to change the setting.

After changing the setting, push the reset button again to restore the menu screen for system setting.

To change the setting of another item, repeat steps 1-4.

After completing all changes, turn the setup dial clockwise to select the end of setting and push the reset button to terminate the system setting mode.

Symbol "TMG" appears on the screen and the normal mode is restored.

Items of system setting

End of setting

The item for terminating the system setting mode. Pushing the reset button returns the screen to the normal mode, terminating the system setting mode.

1. Number of initial bypasses
Set the number of bypasses at the start
(10 to 200) Initial value: 10
2. Absolute value sampling frequency
Set the frequency with which to sample the reference value for absolute value detection.
(1 to 100) Initial value: 10
3. Number of mean values taken
Set the number of times that mean value detection is made.
(1 to 100) Initial value: 10
4. Setting of slowdown
Set the set point for slowdown detection
(-5 to -50%) Initial value: -50% (OFF)
The set point can be set in units of 1%. When it is set to -50%, slowdown detection is turned off.
5. Setting of operation mode
Set the operation mode.
(single, double and multi) Initial value: Double

6. Setting of detection sensitivity
Set detection sensitivity.
(High, Normal and Low) Initial value: Normal
7. Setting of key protection
Set control buttons in the disabled state. Push the button, whose operation is desired to be disabled, to indicate the corresponding mark (P→). The position marked is the position at which the operation has been disabled. To return to the former state (to enable the operation), push the button again to remove the mark (P→). Note that each reset button cannot be disabled. After completing the change, push the reset button to restore the menu screen for system setting.
Initial value: All enabled
8. Setting the reset mode
Set the reset mode, i.e., select whether the device is to be reset manually by pushing the reset button when fault detection is made or is made to be automatically reset one second after fault detection.
Initial value: Manual
9. Setting of counter output timer
Set the output time (one shot) of the counter output relay which provides an output signal when the preset counter value agrees with the preset set point. The set table time is 0.5-25 seconds in units of 0.1 second.
Initial value: 1 second

Connection of Terminal Block

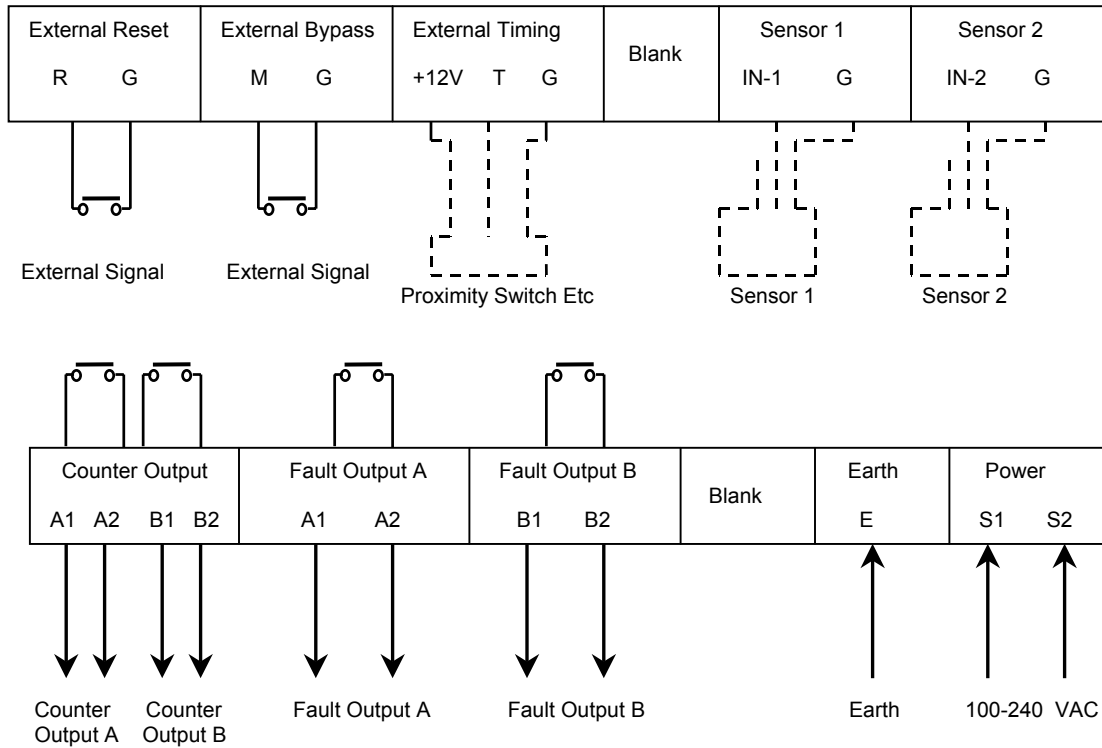

Kind	Contact	Power OFF	Power ON	Fault output being Produced	Counter producing coincidence output
Fault output	A1 A2	OFF	ON	OFF	
	B1 B2	ON	OFF	ON	
Counter output	A1 A2	OFF	OFF	OFF	ON
	B1 B2	ON	ON	ON	OFF

Sensor Installation

Sensor Location

HEADING SLIDE-TOP VIEW FRONT DEAD CENTER POSITION

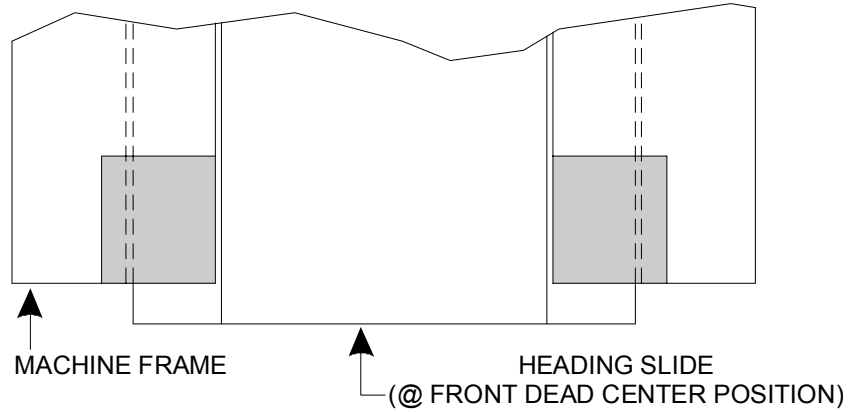

HEADING SLIDE-FRONT VIEW

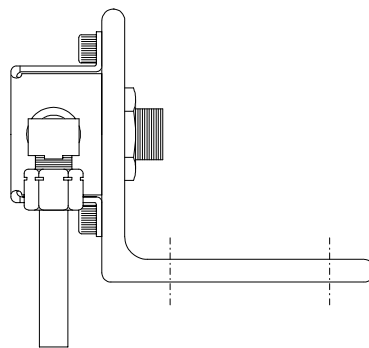
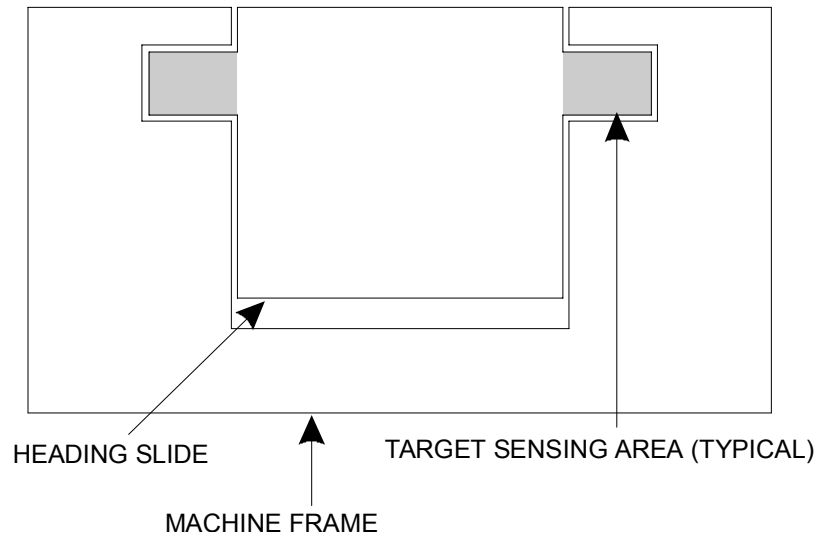

Proximity element and sensor fittings are not attached.
The above figure is for reference only.

Sensor Adjustment

Adjust the sensor as follows:

1. Set the slide at FDC.
2. Push the setup button. The bar display serves as a clearance gauge between sensor and proximity element.

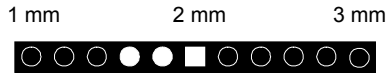

The sensor detection range is 1-3 mm. The leftmost end of the bar display indicates a clearance of less than 1mm and the rightmost end indicates a clearance of 3mm or more. When the clearance is 2mm, only the center square is indicated. One point of the bar display is equivalent to 0.2mm.

3. Set clearance gap between sensor and proximity element to 1.5 to 2.0 mm (.059"~.078").

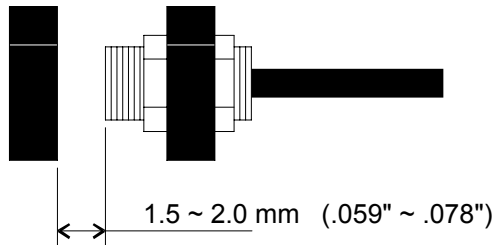

4. Place material and operate the machine in the continuous mode. Confirm that the bar display shows a value between 1.7 and 2.2mm. Placing material causes the FDC position to displace a little, so make this confirmation without fail with material placed in the machine. If the FDC position is displaced, stop the machine and adjust the proximity element and then confirm again.
5. Push the setup button to cancel the setup mode.
When you push the setup button to get into the setup mode, the bar display operates as the clearance gauge for the sensor. When the machine is in the stop state, the bar display measures and shows the distance of clearance at all times. When the machine is operating, it measures and shows the distance of the smallest clearance within one stroke.

Trouble Shooting Guide

Trouble	Possible Cause and Remedy
Screen difficult to see (dark or light).	Turn the contrast control beneath the setup dial to adjust the screen so as to be easy to see.
Back light not turned on.	Power supply not turned on. Check power supply, power terminal, etc.
Device operating normally, but back light not turned on.	LCD unit faulty. Request repair.
Sensor trouble indicated.	Sensor, sensor connection or sensor cable not good. If there is no problem with connection, replace sensor.
“EE” appears on deviation display and machine stops.	Clearance between sensor and proximity element improperly adjusted. Readjust.
Product is normal, but machine stops frequently.	Loose sensor and proximity element or non-conforming set point. Check for installation of sensor. If there is no problem, readjust set point.
Strange indication appears sometimes. With this, machine stops.	Effect of external noise. Rather strong noise or something like it is considered to be produced, so remove the noise source or install a noise filter to the power input section, fault output section, counter output section, external timing input section, etc. of the device.
Commands from control buttons not accepted.	When a button is key protected, the button being key protected is indicated on the display, so cancel this key protection by system setting. When machine is operating at high speeds, commands from control buttons are not accepted in some cases because detection operation is given priority. Stop machine before operation.
Fault detection always performed at machine stop.	This state occurs when slowdown detection is set. Fault output is produced only one second after stop, but this does not mean malfunction. The output is produced by fail-safe operation.
“S” and “Timing” stay on display	When machine is operated at high speeds, these symbols stay on display.
“Sampling” does or does not appear.	“Sampling” appears when the reference value for absolute value detection is not sampled or being sampled. It disappears upon completion of reference value sampling. However, when machine stops, “sampling” is indicated and the device gets in the wait state for sampling.

